

Ø8 × 35		Ø8 × 24					
A 18×	B 8×	C 8×	D 8×	E 4×	F 4×	G 8×	H 8×

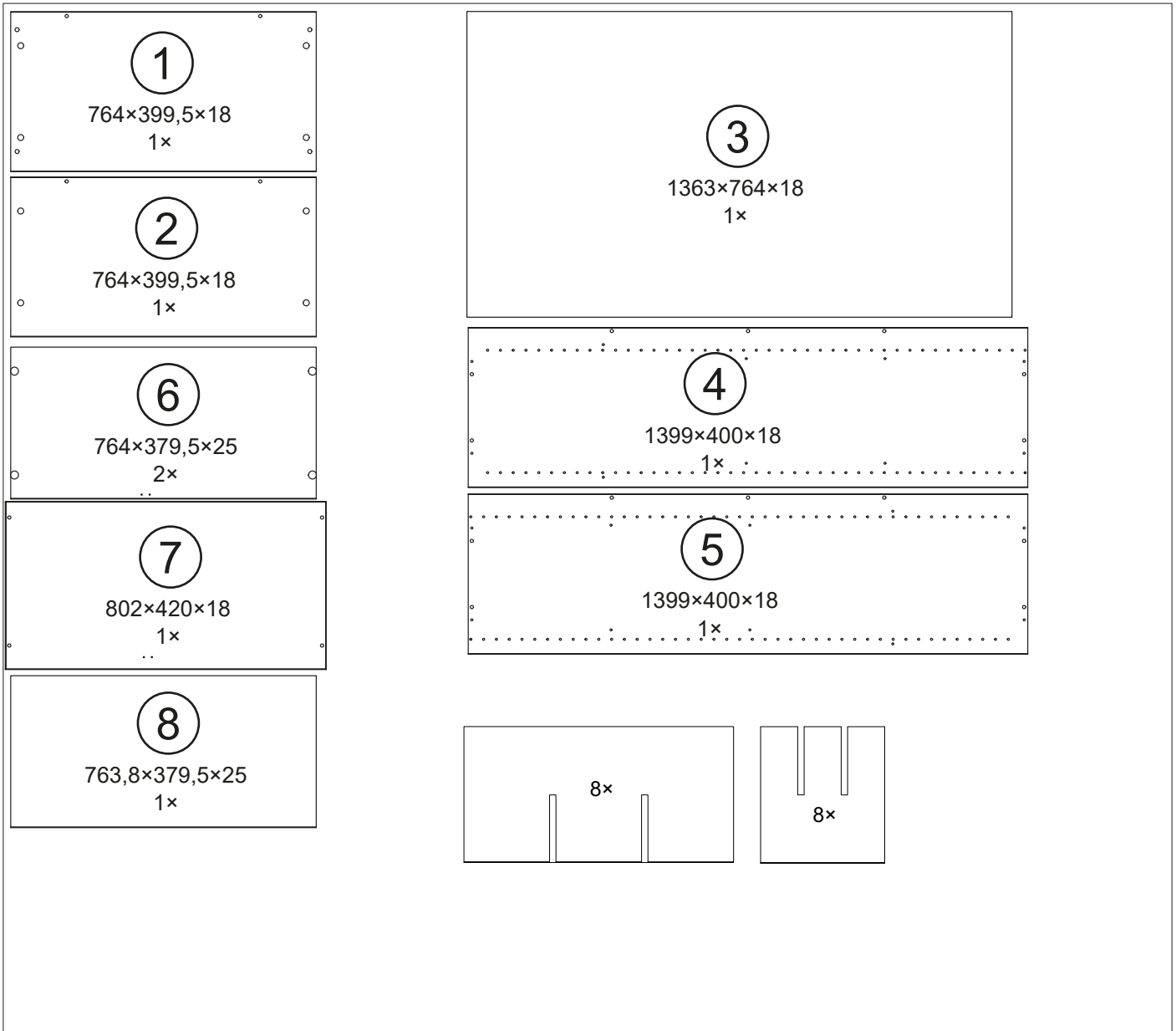

Ø8 × 27
I 4×

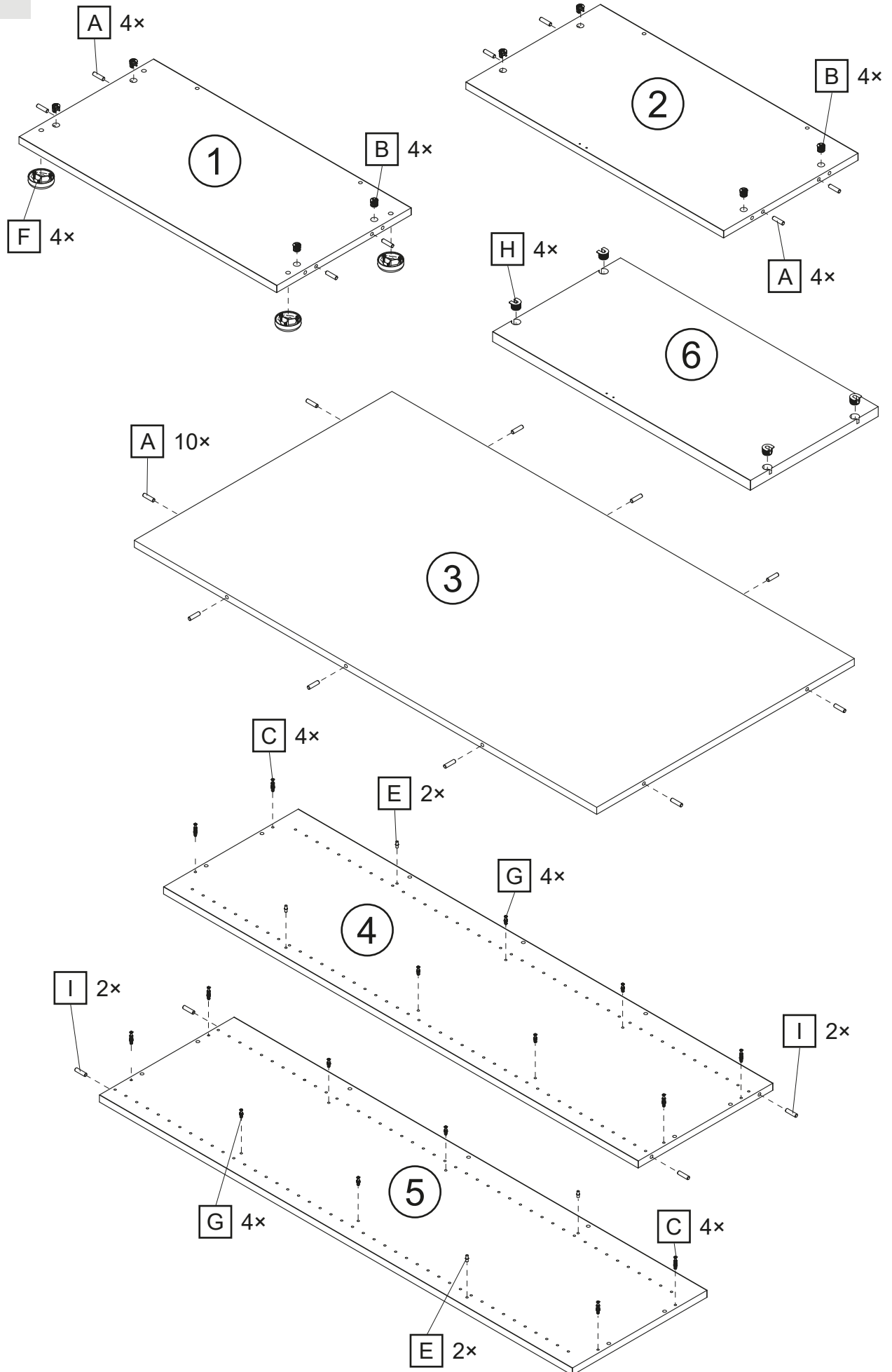

1

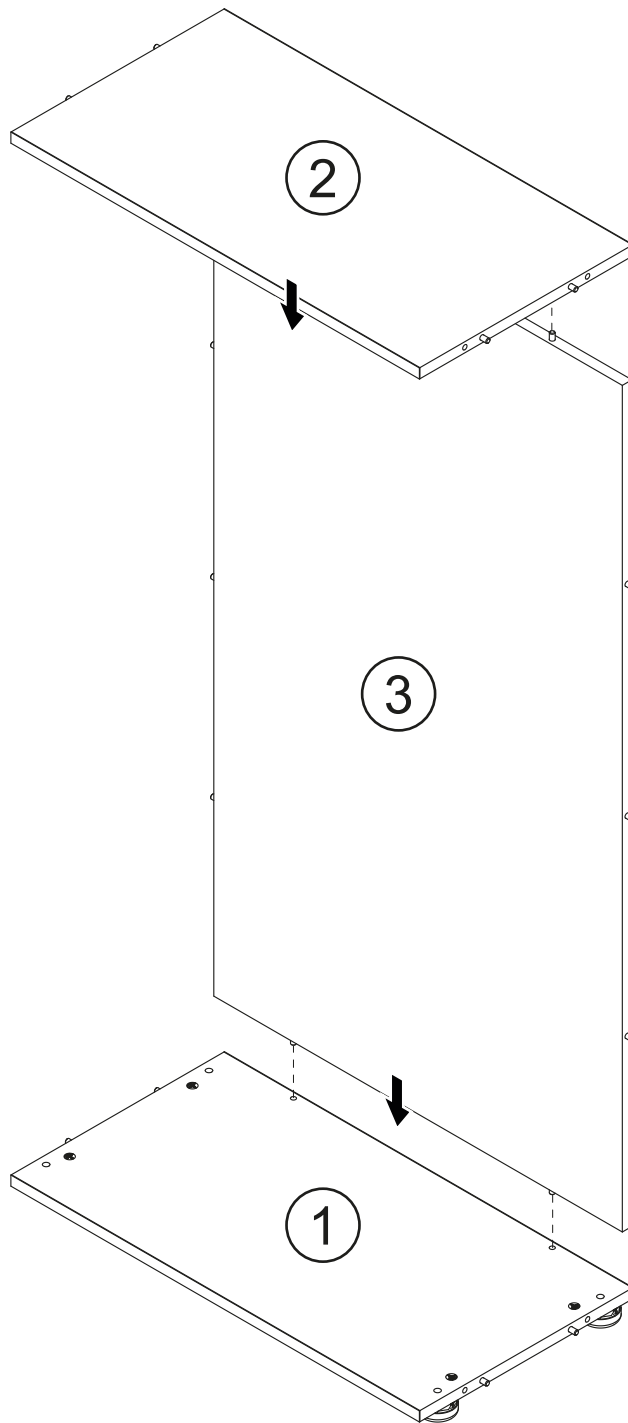

2



3

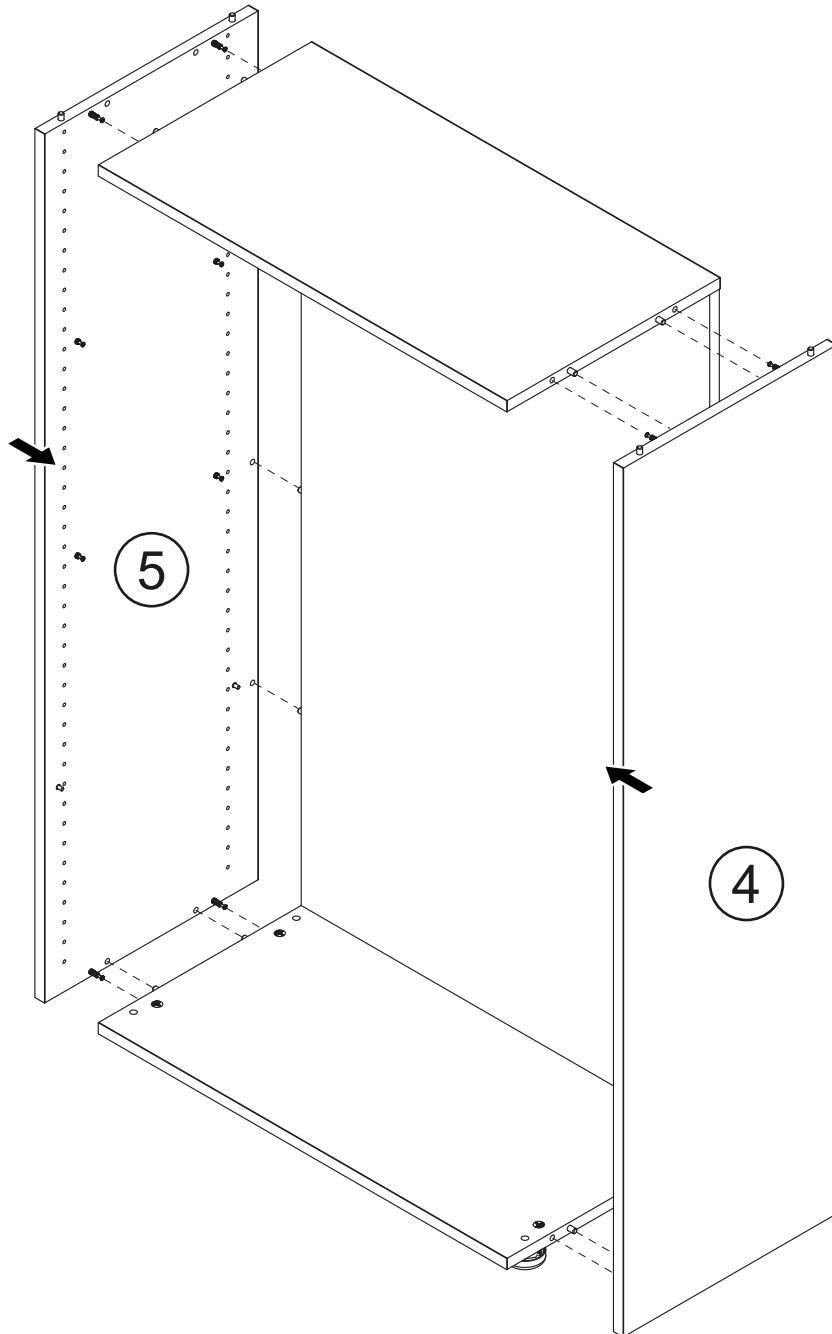

4

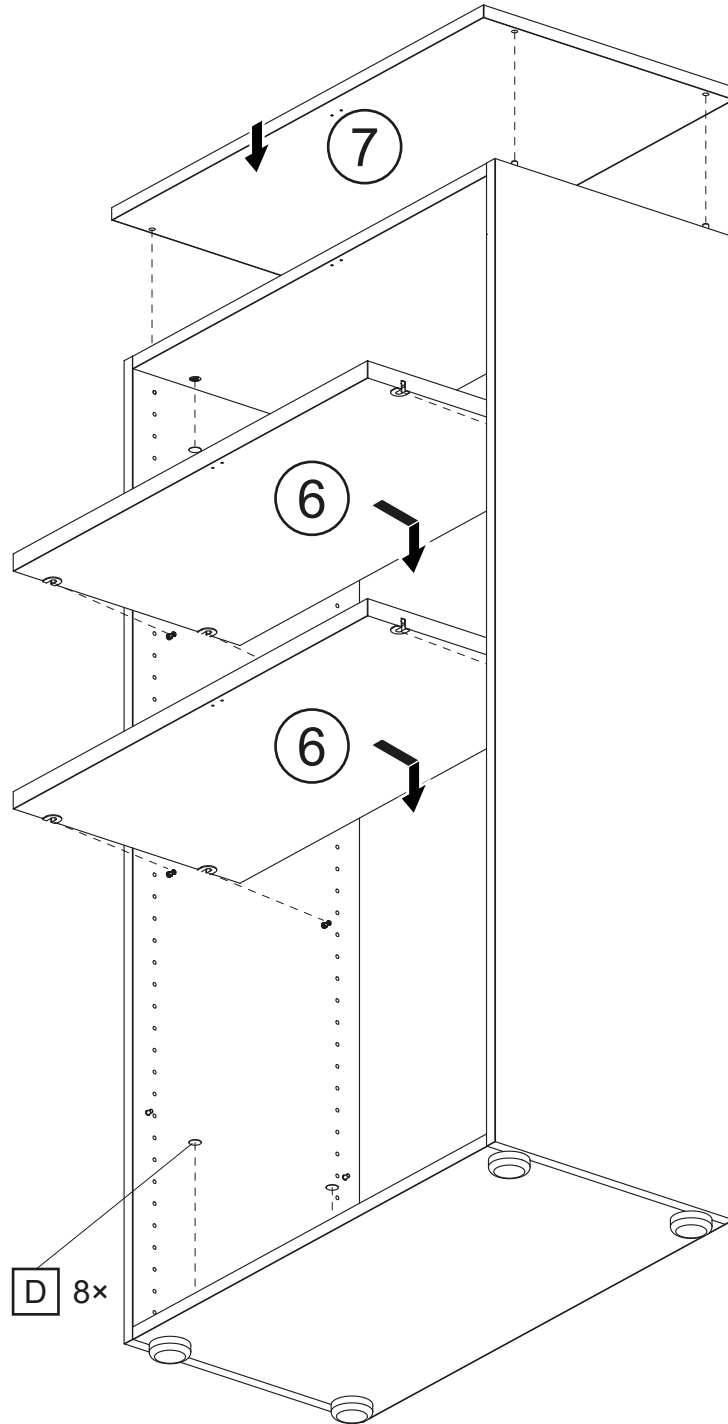

5

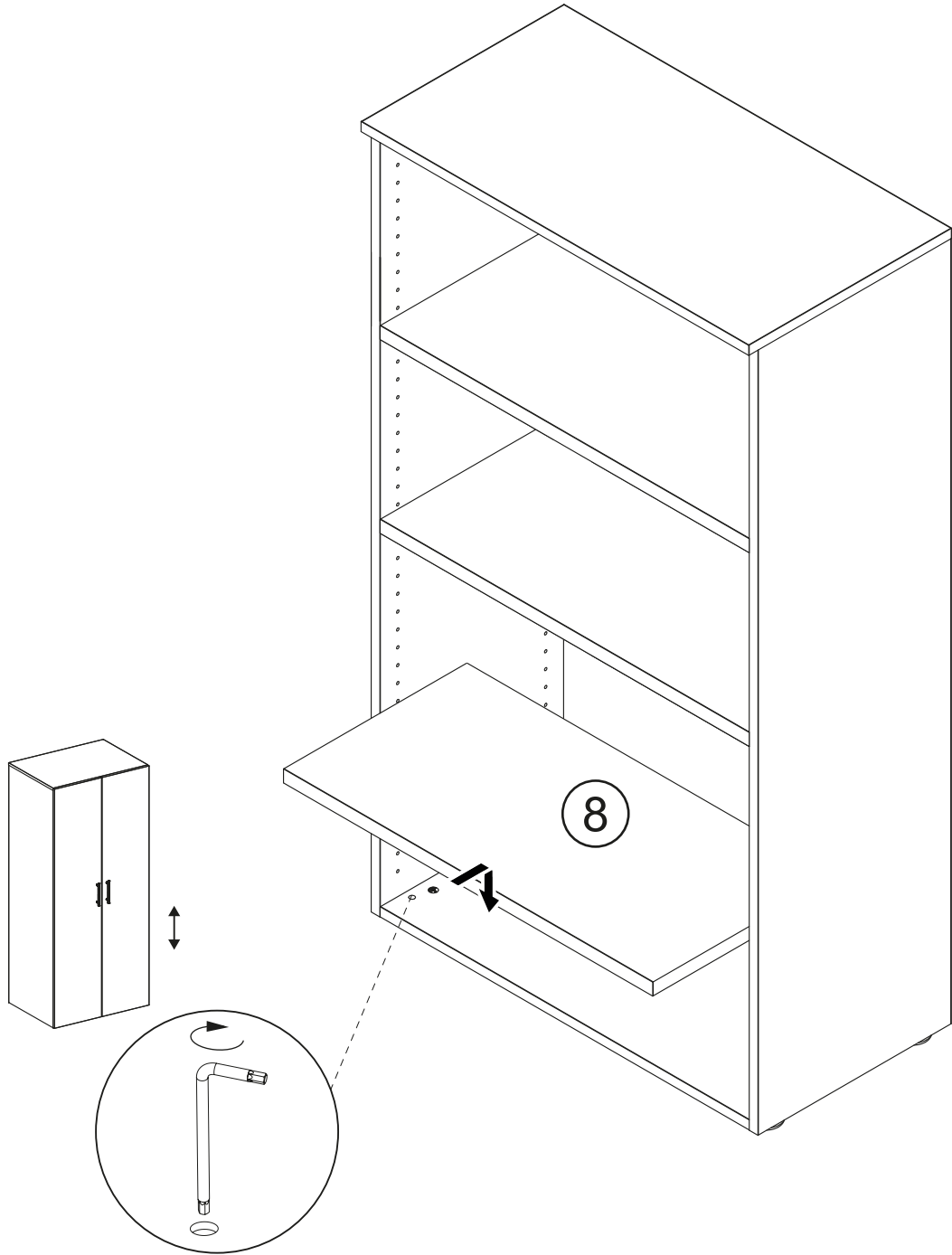

6 4x

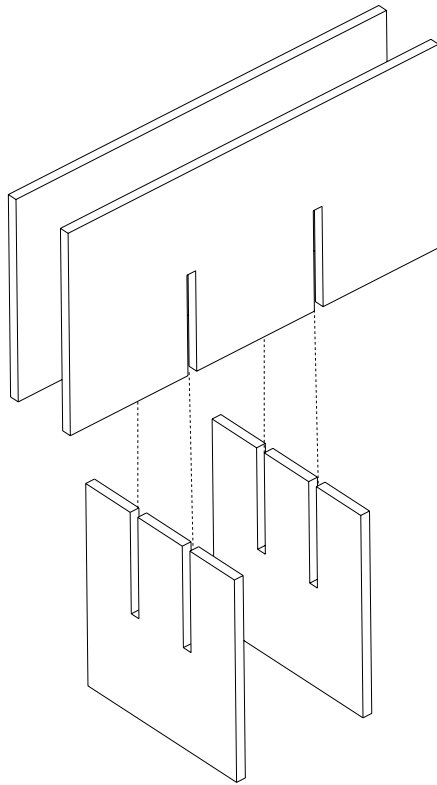

7

