

Ø8 × 35		Ø8 × 24					
A 18×	B 8×	C 8×	D 8×	E 8×	F 4×	G 8×	H 8×
							
Ø8 × 27							
I 4×							

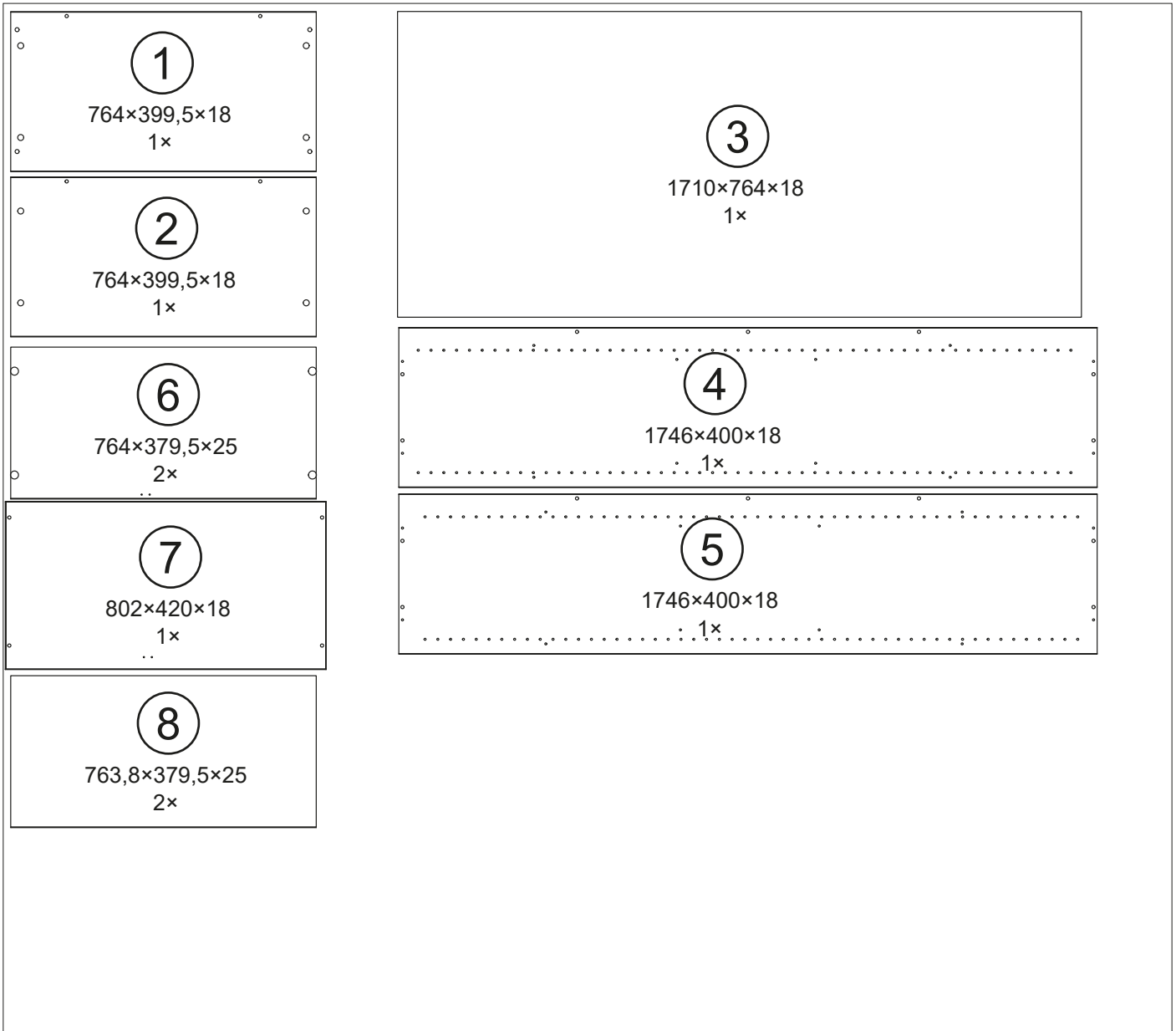

1

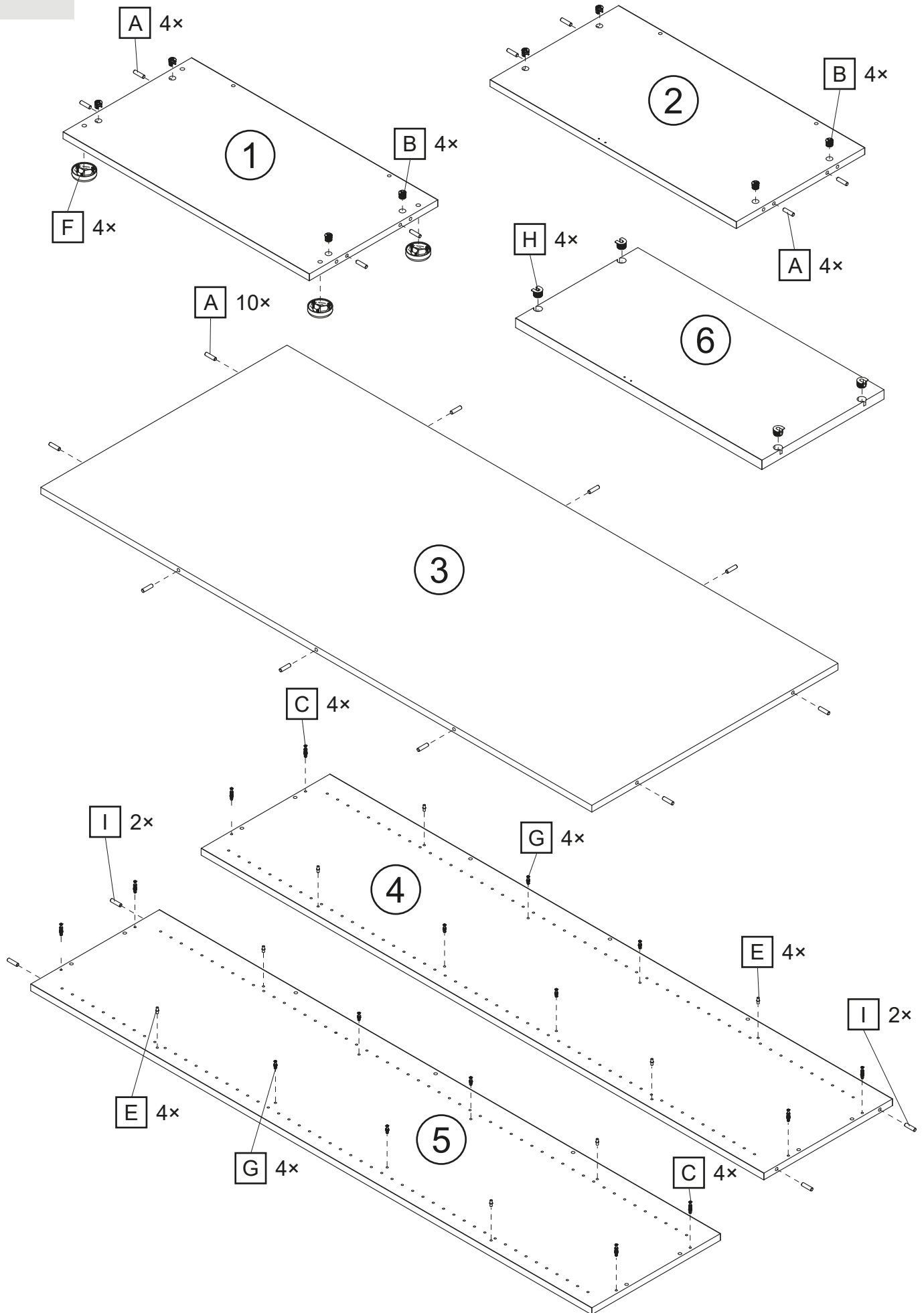
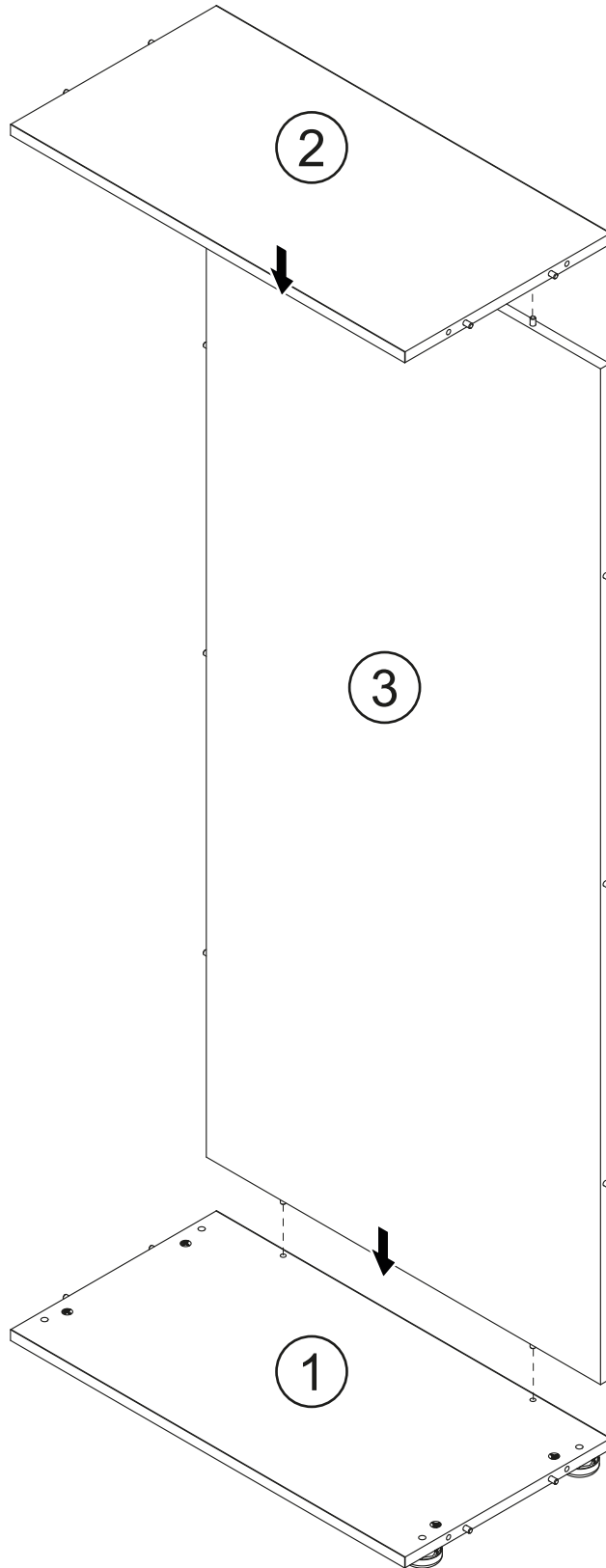

2



3

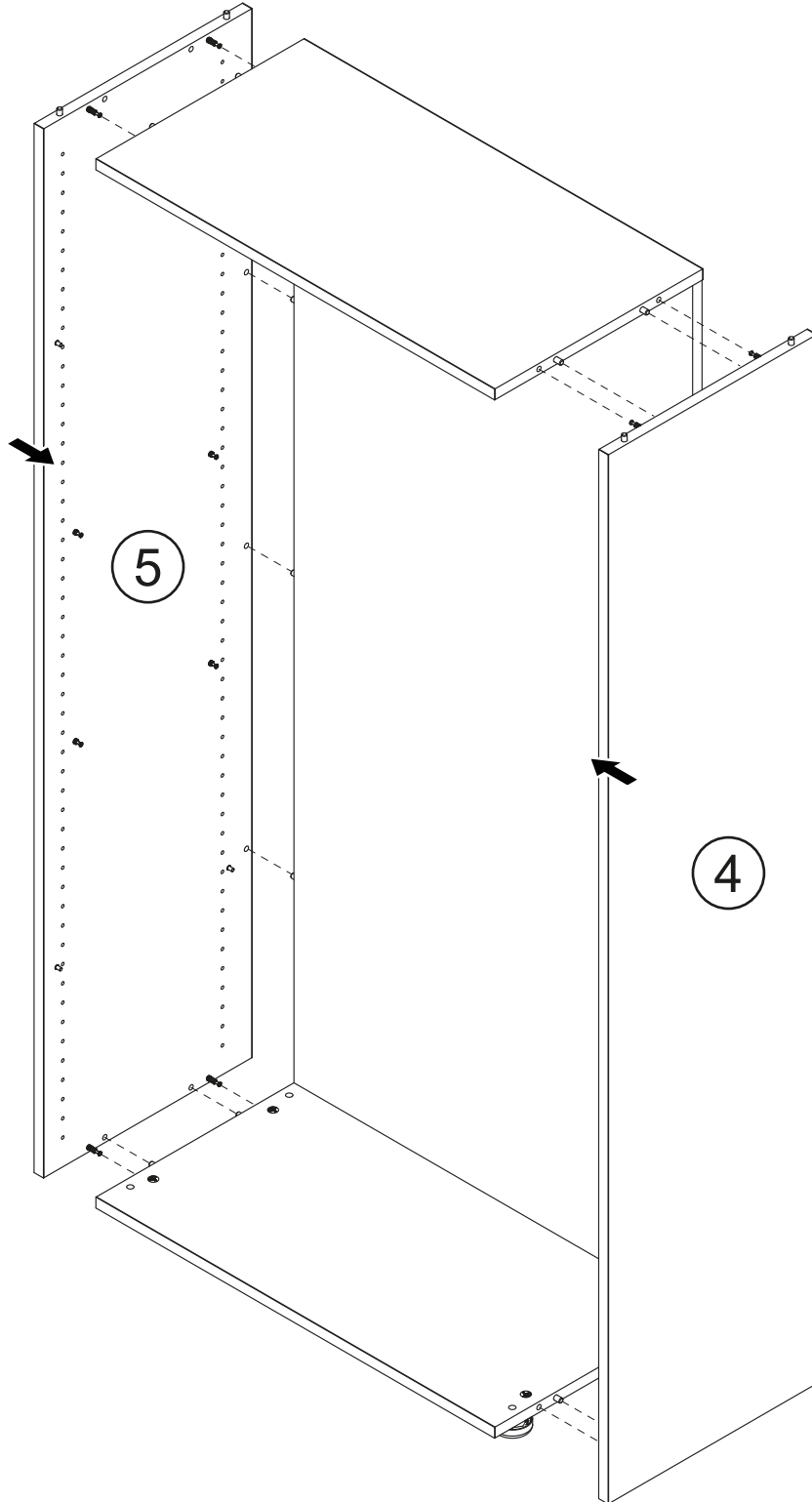

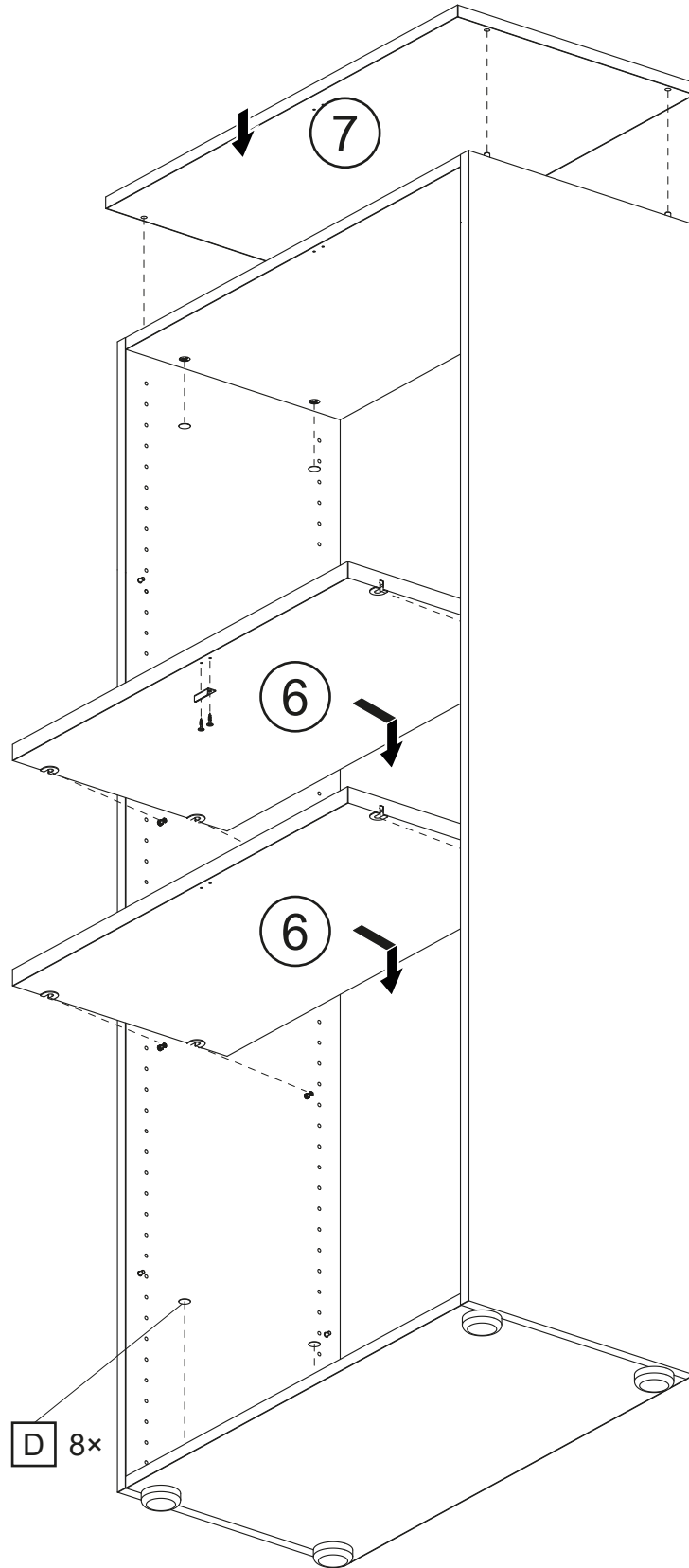

5

