

10
2xN.

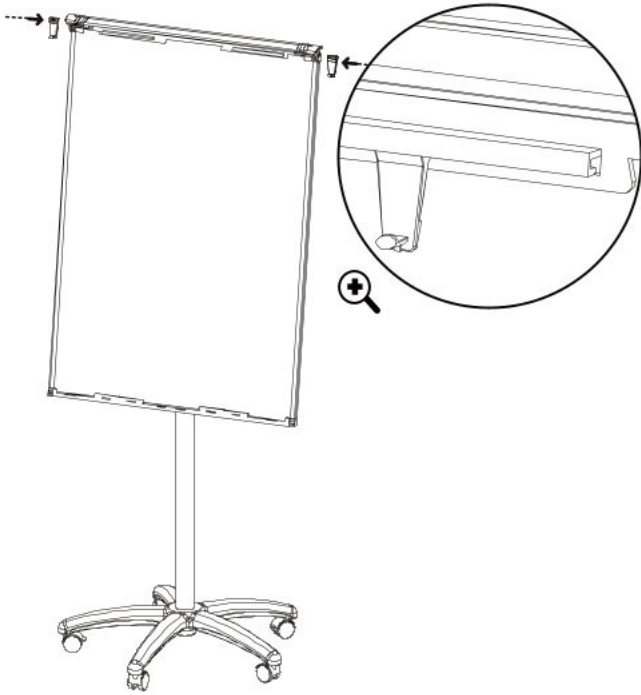

11

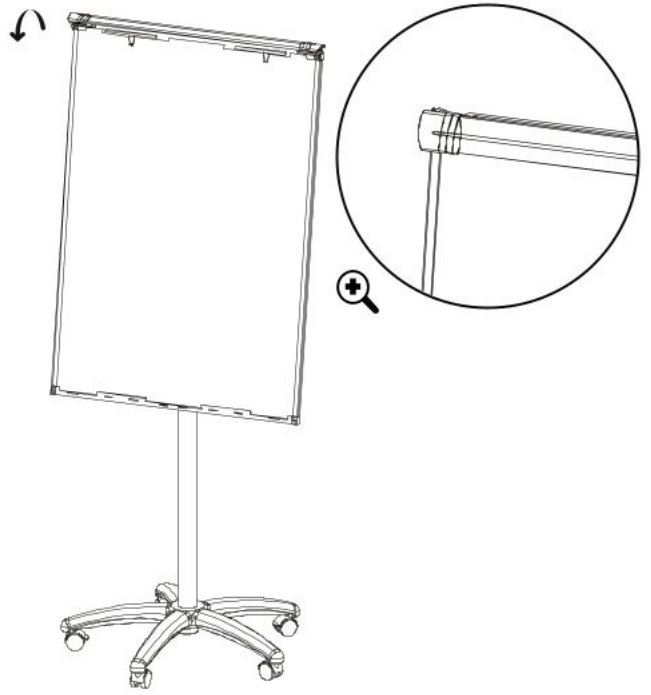



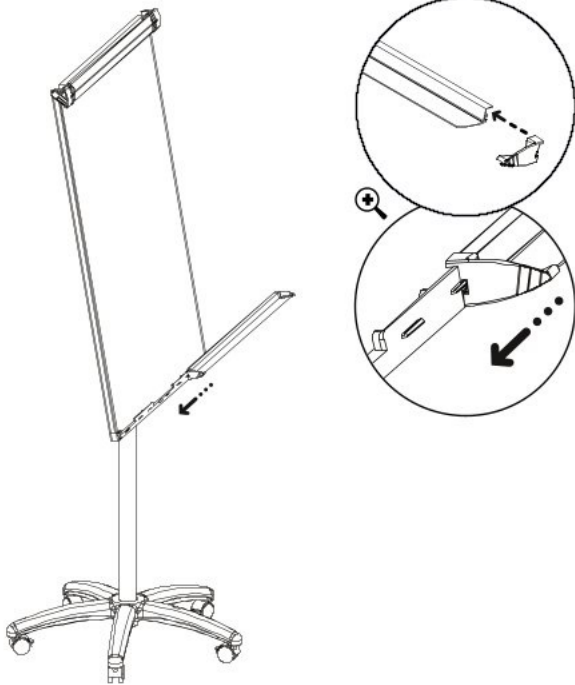



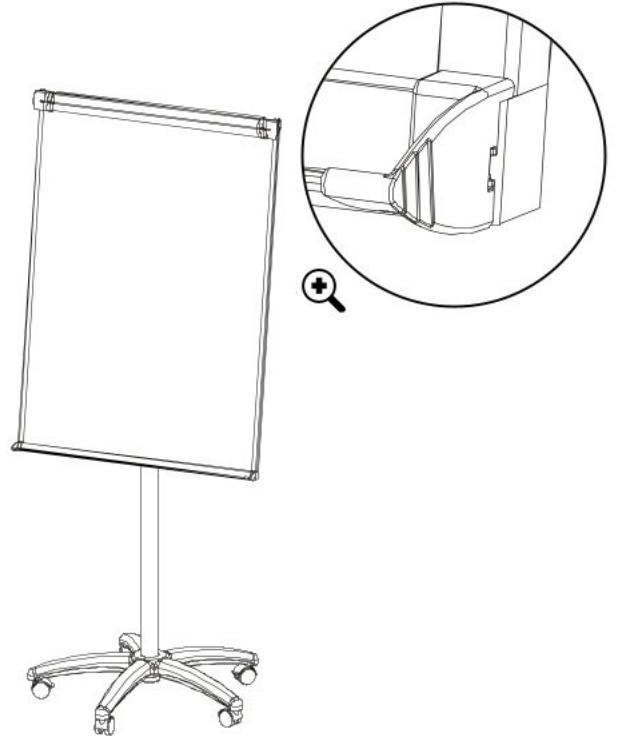

















12
1xT.
2xV.



13



- | | | | | | | | | | | | |
|---------------------------------------------------------------------------------------------------|----------------------------------------------------------------------------------------------------|----------------------------------------------------------------------------------------------------|----------------------------------------------------------------------------------------------------|----------------------------------------------------------------------------------------------------|----------------------------------------------------------------------------------------------------|----------------------------------------------------------------------------------------------------|----------------------------------------------------------------------------------------------------|------------------------------------------------------------------------------------------------------|------------------------------------------------------------------------------------------------------|------------------------------------------------------------------------------------------------------|------------------------------------------------------------------------------------------------------|
| A.1x
 | B.1x
 | C.4x
 | D.1x
 | E.3x
 | F.1x
 | G.1x
 | H.1x
 | I.5x
 | J.1x
 | K.1x
 |  |
| L.1x
 | M.2x
 | N.2x
 | O.1x
 | P.1x
 | Q.1x
 | R.1x
 | S.1x
 | T.1x
 | U.2x
 | V.2x
 | W.2x
 |

1 A
1x.A.
2x.W.

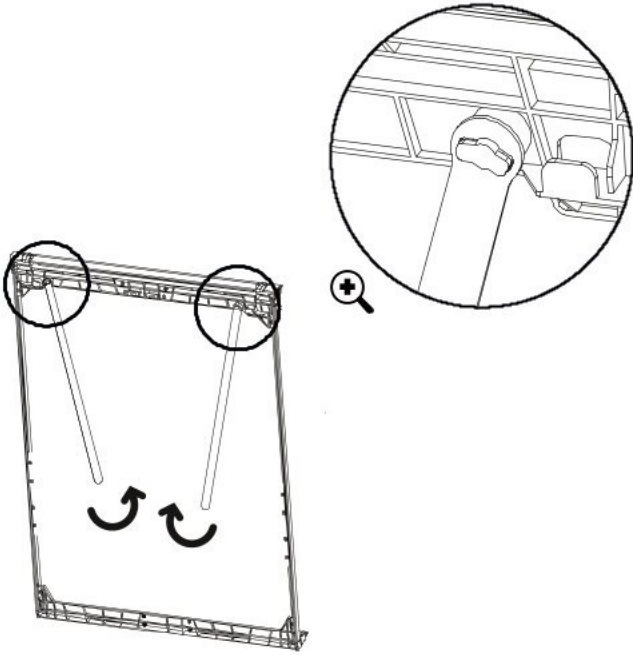



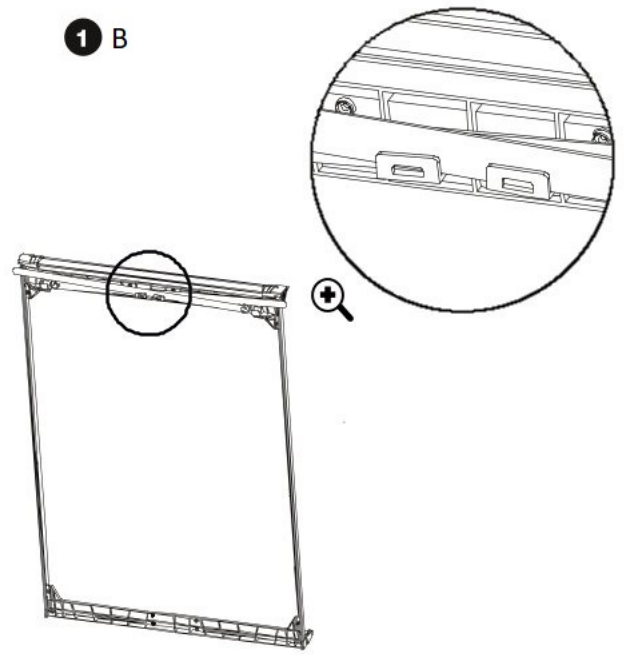



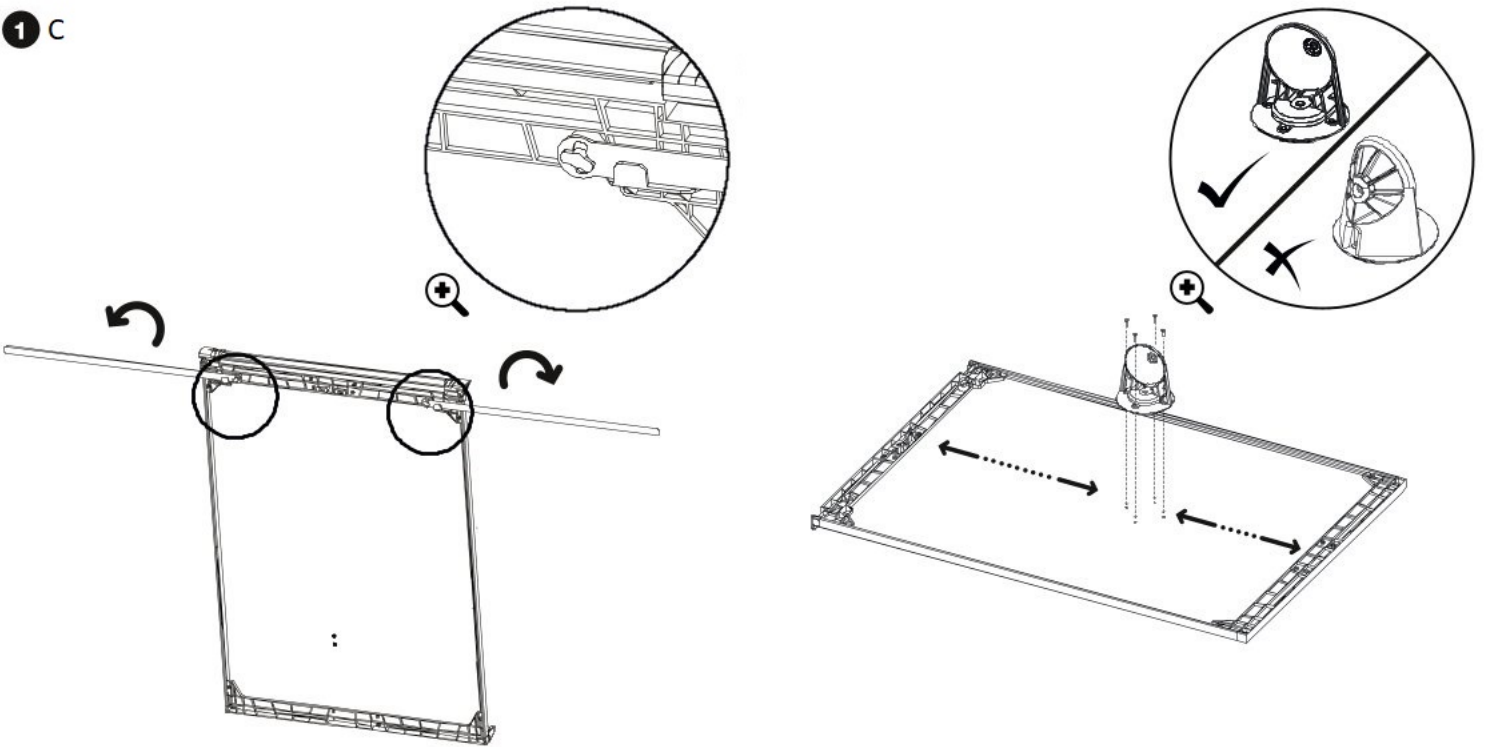

















1 B



1 C



- | | | | | | | | | | | | |
|---------------------------------------------------------------------------------------------------|----------------------------------------------------------------------------------------------------|----------------------------------------------------------------------------------------------------|----------------------------------------------------------------------------------------------------|----------------------------------------------------------------------------------------------------|----------------------------------------------------------------------------------------------------|----------------------------------------------------------------------------------------------------|----------------------------------------------------------------------------------------------------|------------------------------------------------------------------------------------------------------|------------------------------------------------------------------------------------------------------|------------------------------------------------------------------------------------------------------|------------------------------------------------------------------------------------------------------|
| A.1x
 | B.1x
 | C.4x
 | D.1x
 | E.3x
 | F.1x
 | G.1x
 | H.1x
 | I.5x
 | J.1x
 | K.1x
 |  |
| L.1x
 | M.2x
 | N.2x
 | O.1x
 | P.1x
 | Q.1x
 | R.1x
 | S.1x
 | T.1x
 | U.2x
 | V.2x
 | W.2x
 |

2

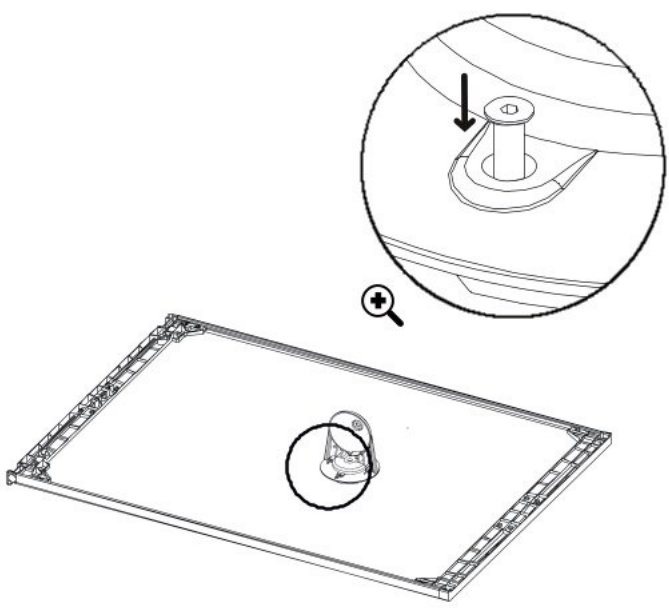

3

1xD.
3xE.

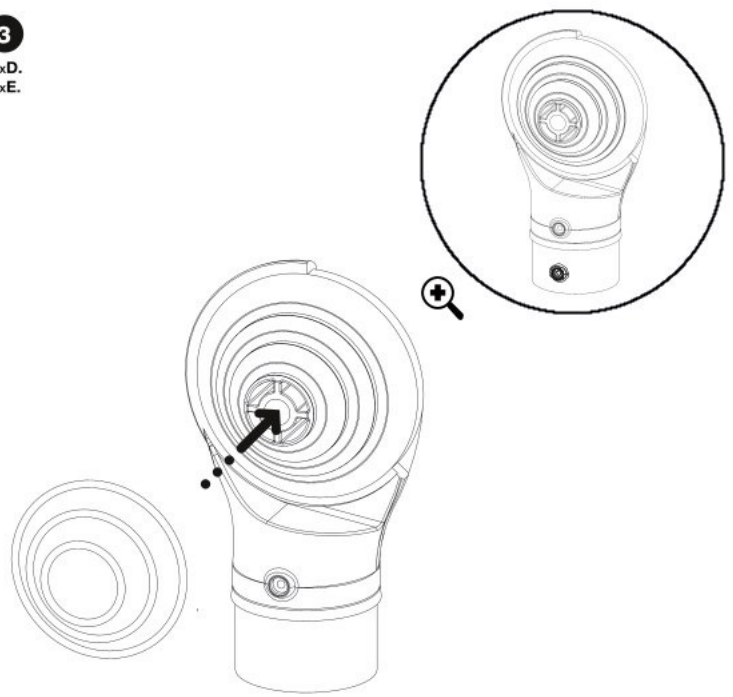





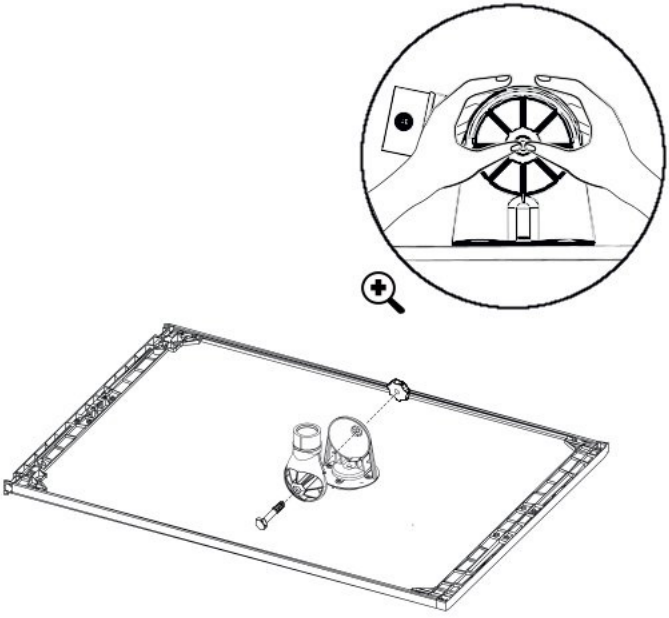



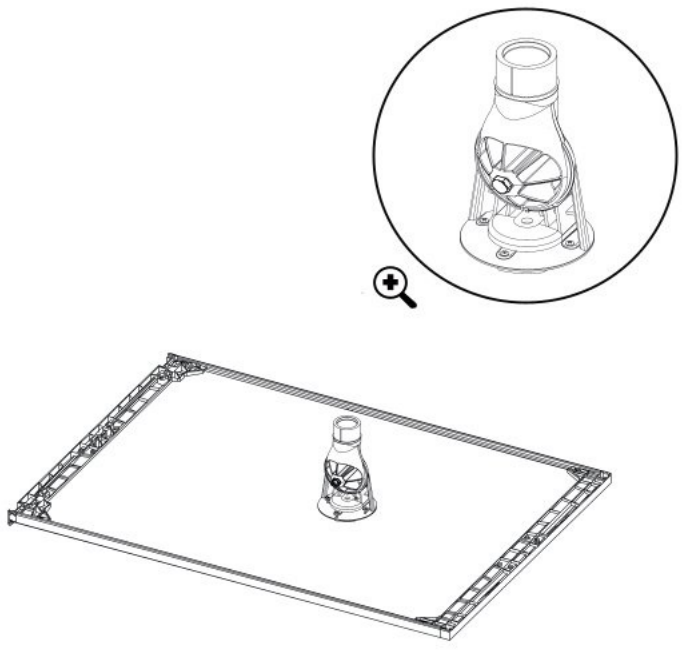















4

1xF.
1xG.



5



- | | | | | | | | | | | | |
|---------------------------------------------------------------------------------------------------|----------------------------------------------------------------------------------------------------|----------------------------------------------------------------------------------------------------|----------------------------------------------------------------------------------------------------|----------------------------------------------------------------------------------------------------|----------------------------------------------------------------------------------------------------|----------------------------------------------------------------------------------------------------|----------------------------------------------------------------------------------------------------|------------------------------------------------------------------------------------------------------|------------------------------------------------------------------------------------------------------|------------------------------------------------------------------------------------------------------|------------------------------------------------------------------------------------------------------|
| A.1x
 | B.1x
 | C.4x
 | D.1x
 | E.3x
 | F.1x
 | G.1x
 | H.1x
 | I.5x
 | J.1x
 | K.1x
 |  |
| L.1x
 | M.2x
 | N.2x
 | O.1x
 | P.1x
 | Q.1x
 | R.1x
 | S.1x
 | T.1x
 | U.2x
 | V.2x
 | W.2x
 |

6

1xH.
5xI.
1xJ.
1xK.
1xL.
1xO.
1xQ.
1xR.

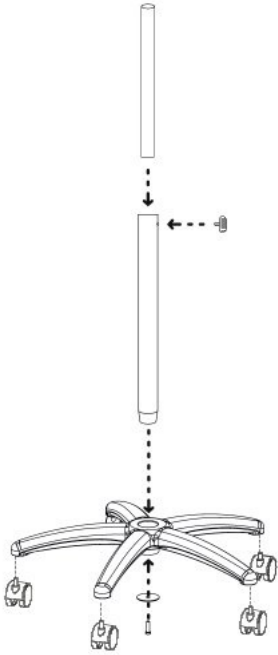

7

2xM.

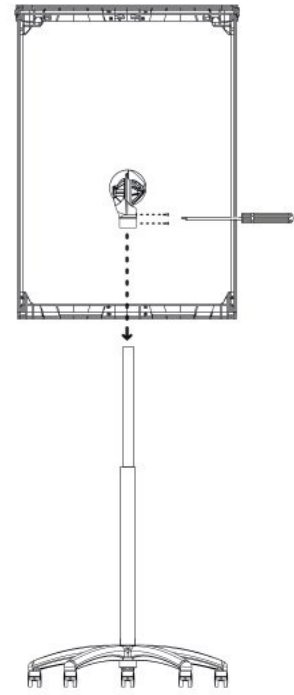

8

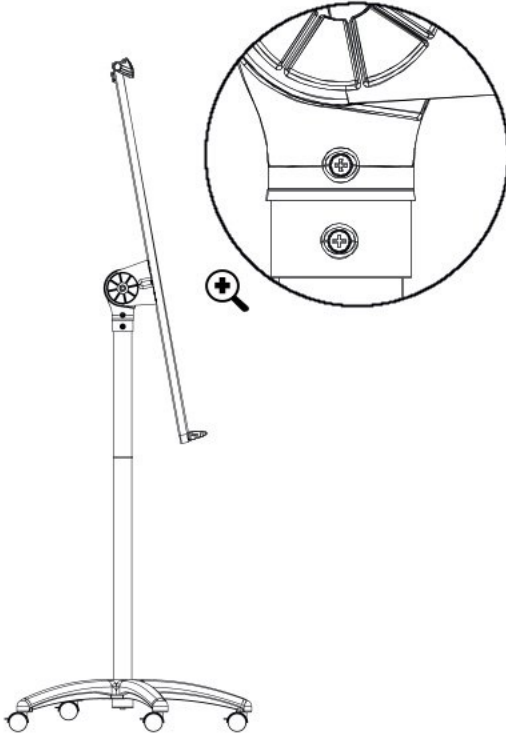

9

1xS.
2xU.

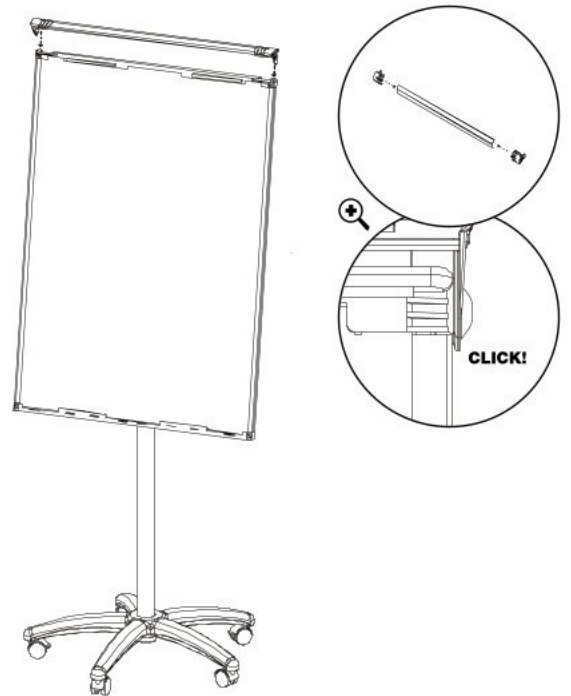

A.1x



B.1x



C.4x



D.1x



E.3x



F.1x



G.1x



H.1x



I.5x



J.1x



K.1x



1000138010972_REV04



L.1x



M.2x



N.2x



O.1x



P.1x



Q.1x



R.1x



S.1x



T.1x



U.2x



V.2x



W.2x

