

A

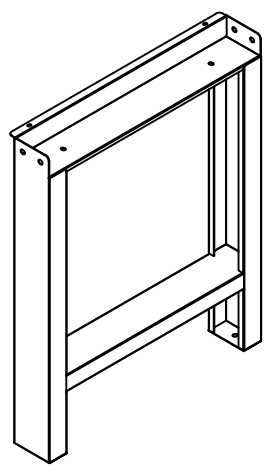

1Pc

B

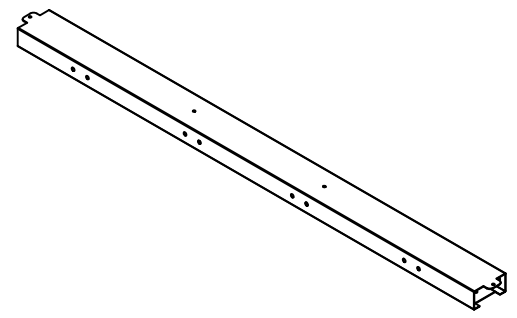

2Pcs

C

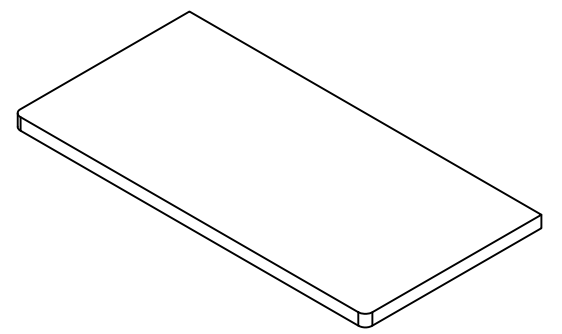

1Pc

D

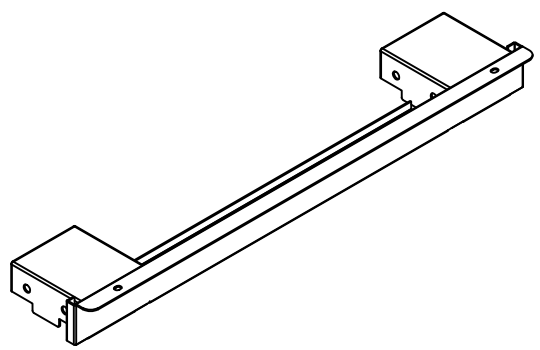

1Pc

E

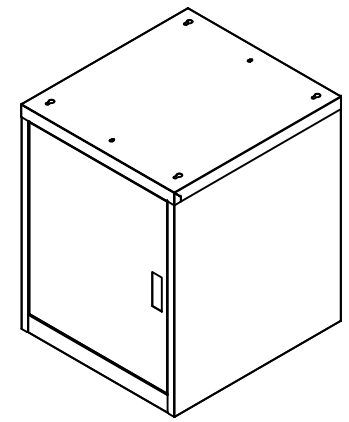

1Pc

a

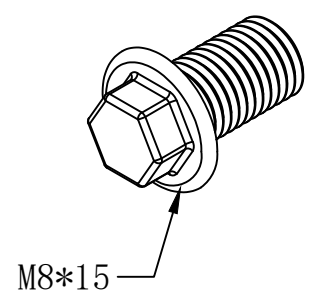

M8*15

8Pcs

b

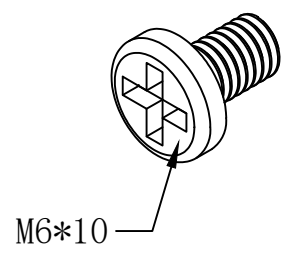

M6*10

6Pcs

c

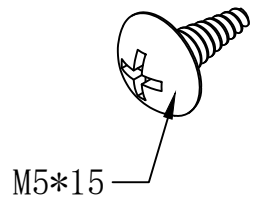

M5*15

8Pcs

1

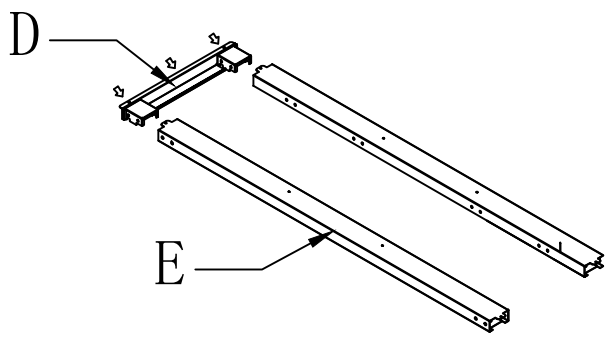

2

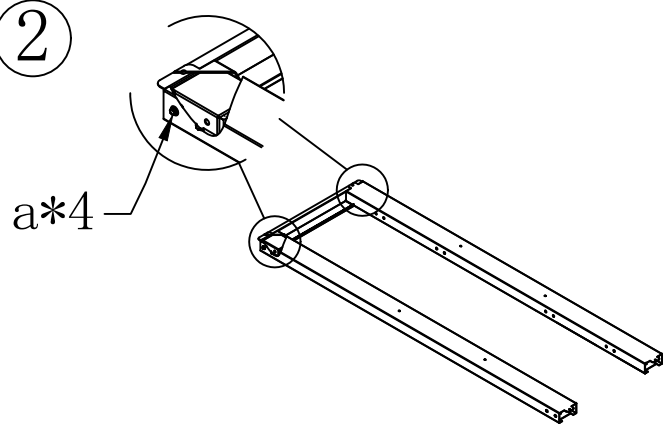

3

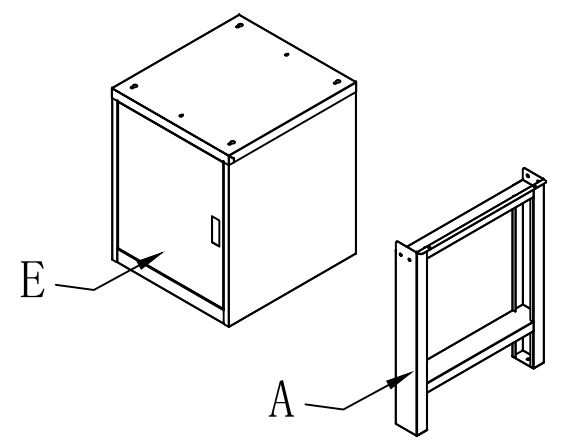

4

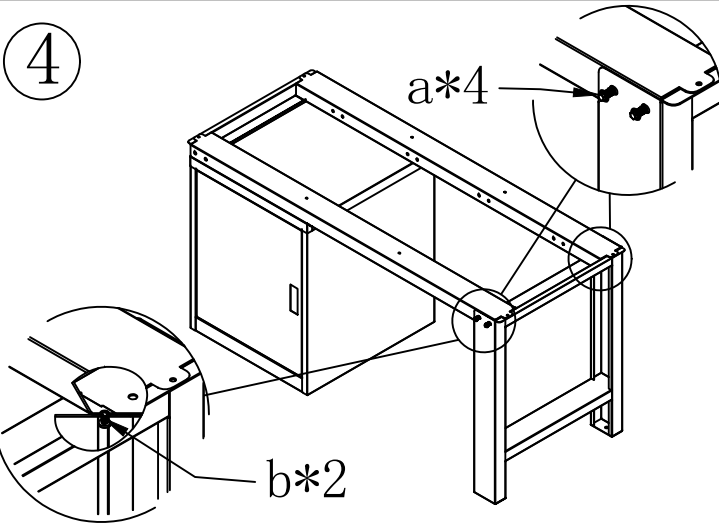

5

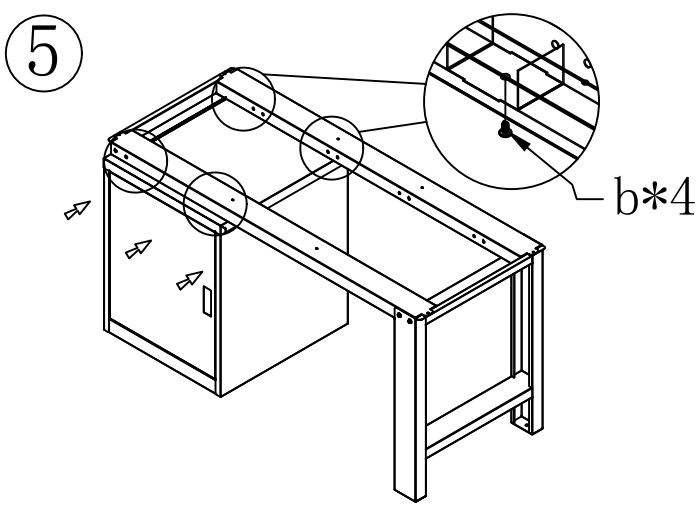

6

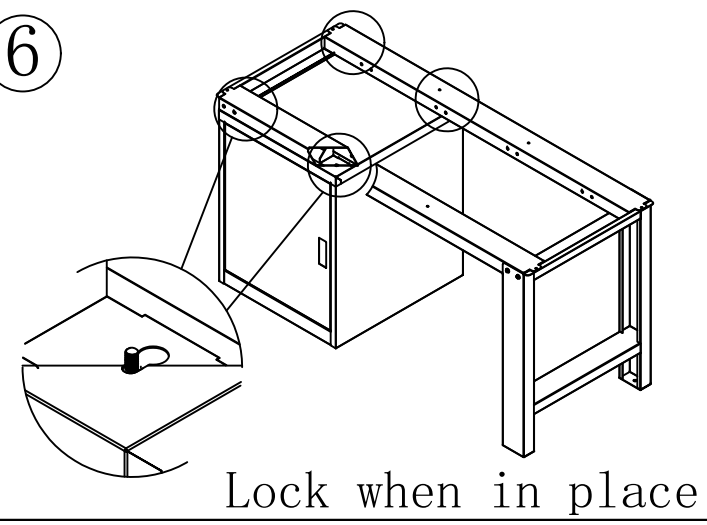

7

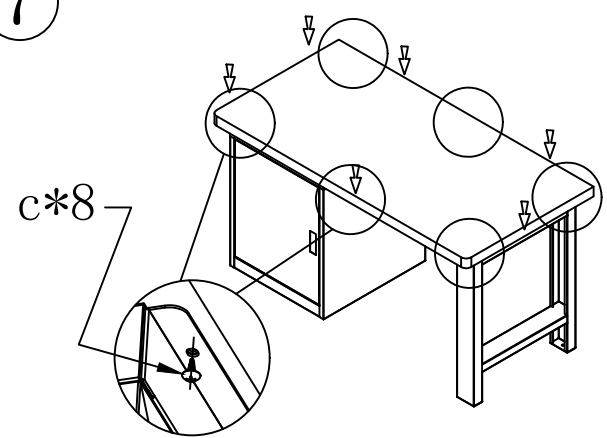

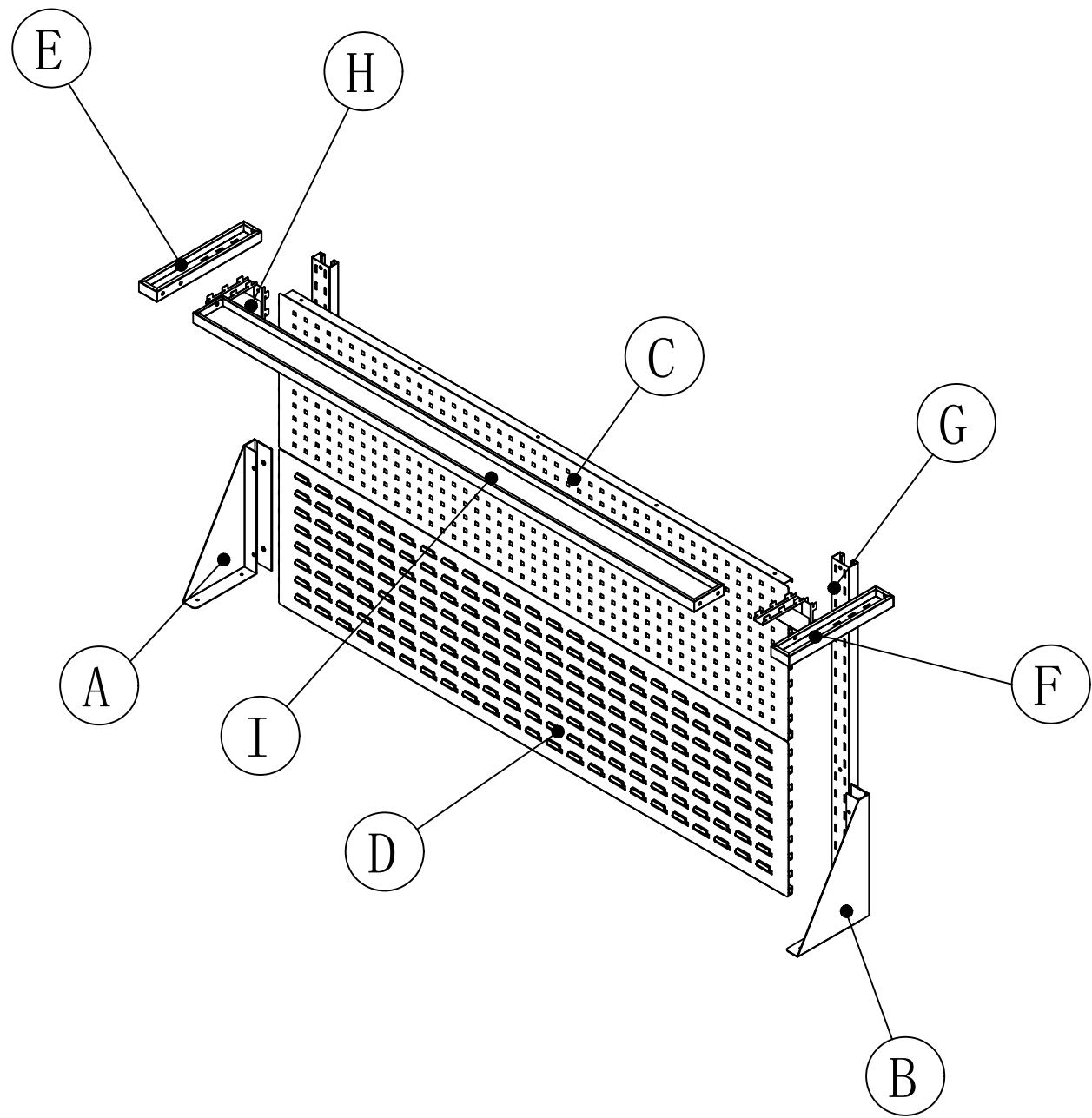
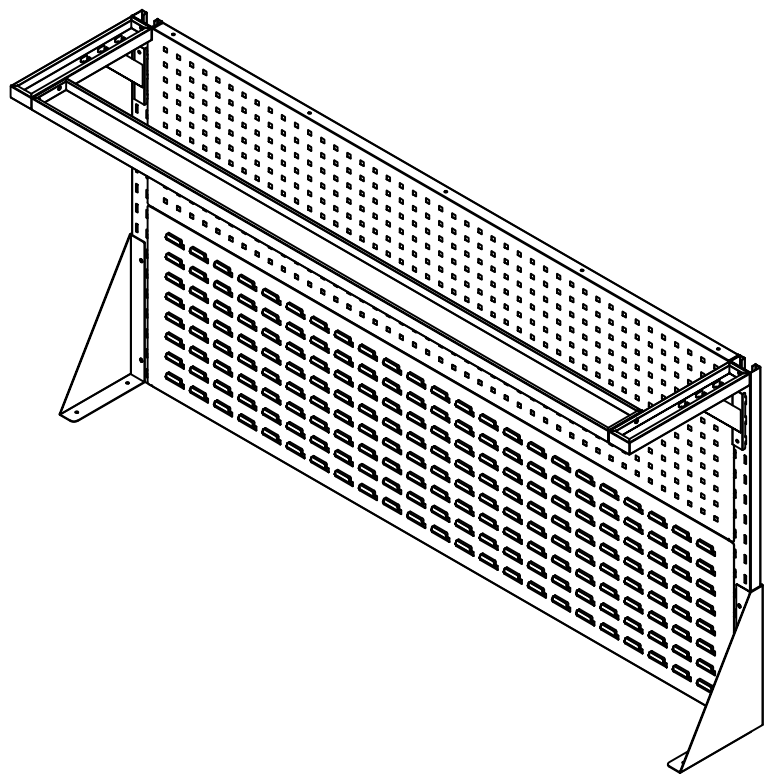

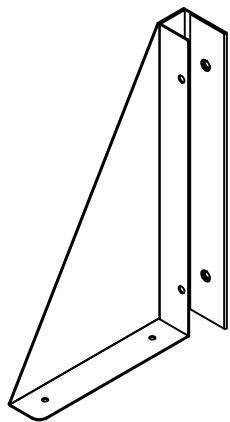
A

1Pc

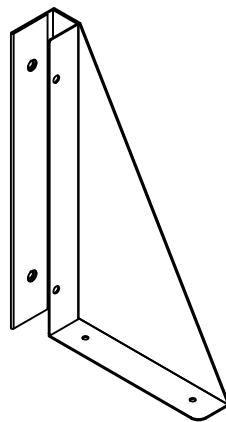
B

1Pc

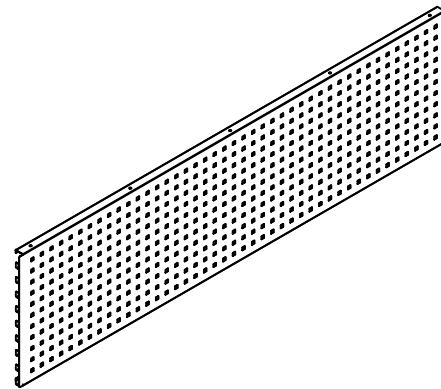
C

1Pc

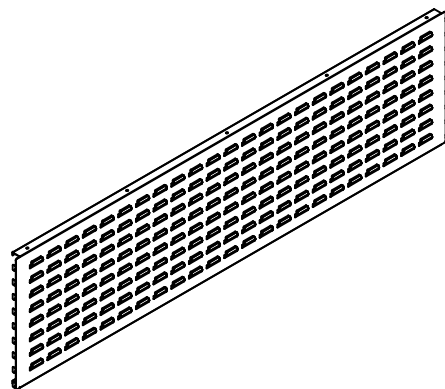
D

1Pc

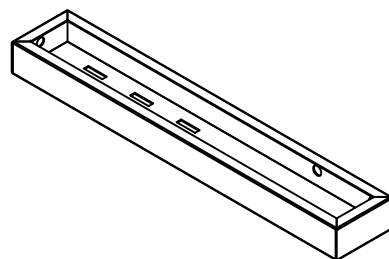
E

1Pc

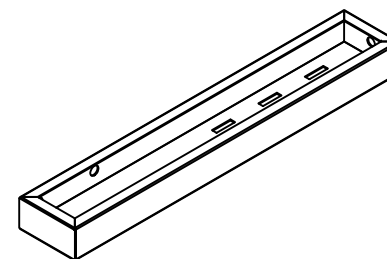
F

1Pc

G

2Pcs

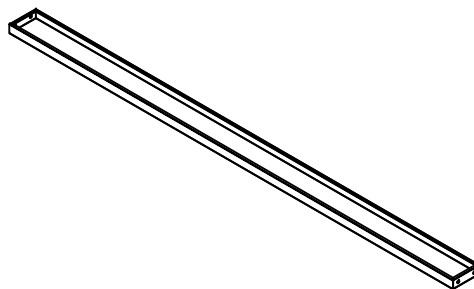
H

1Pc

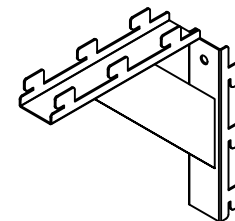
I

2Pcs

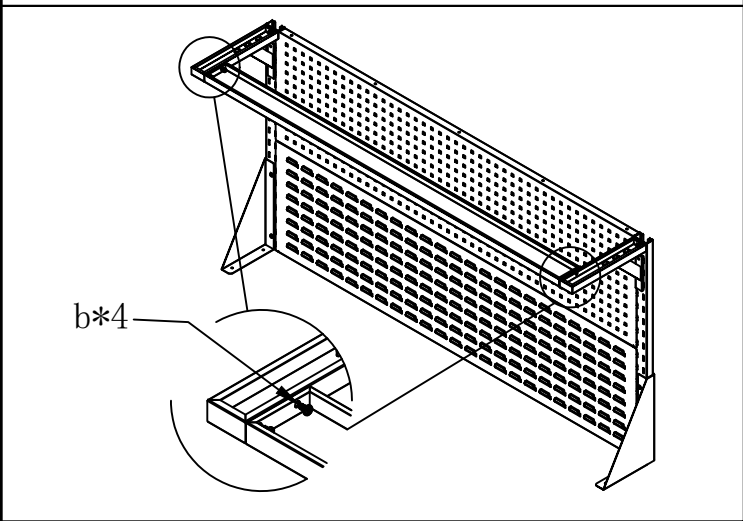
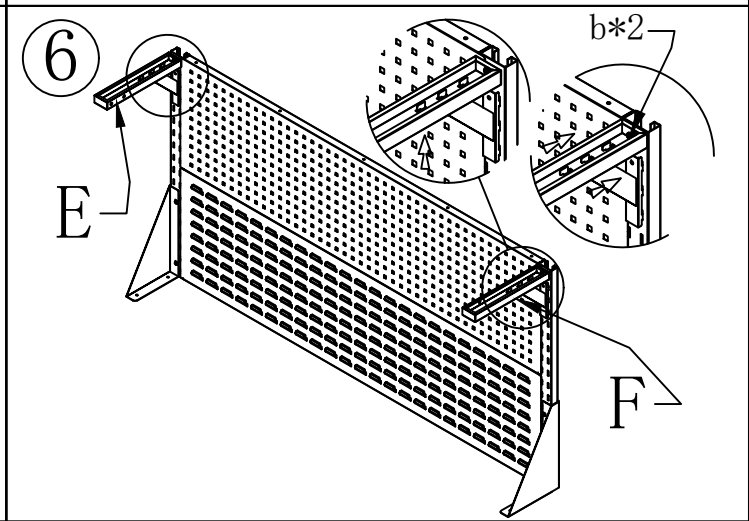
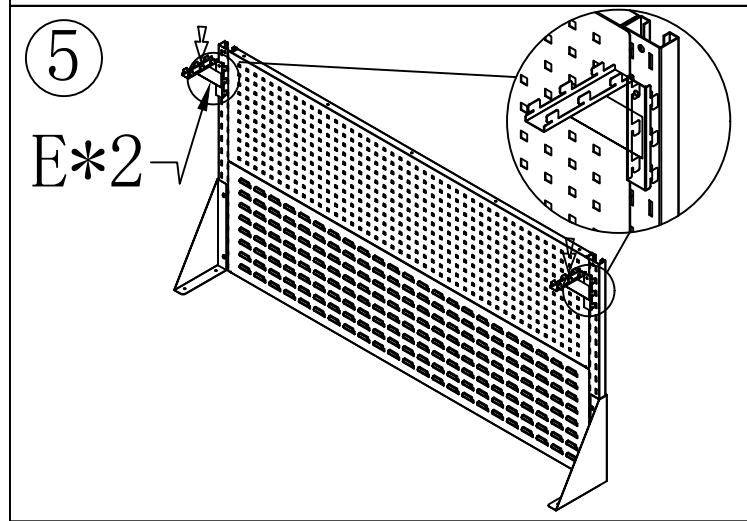
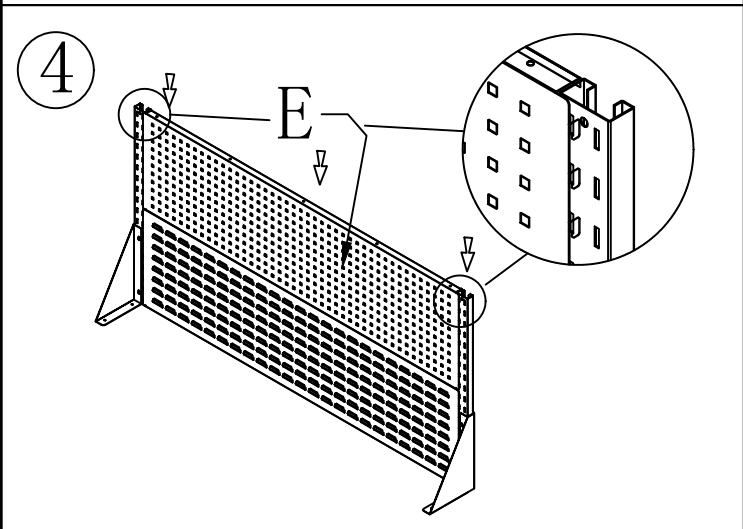
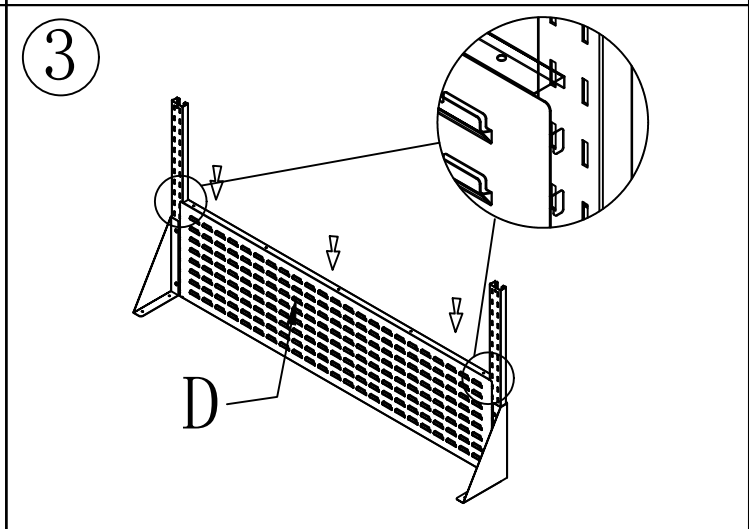
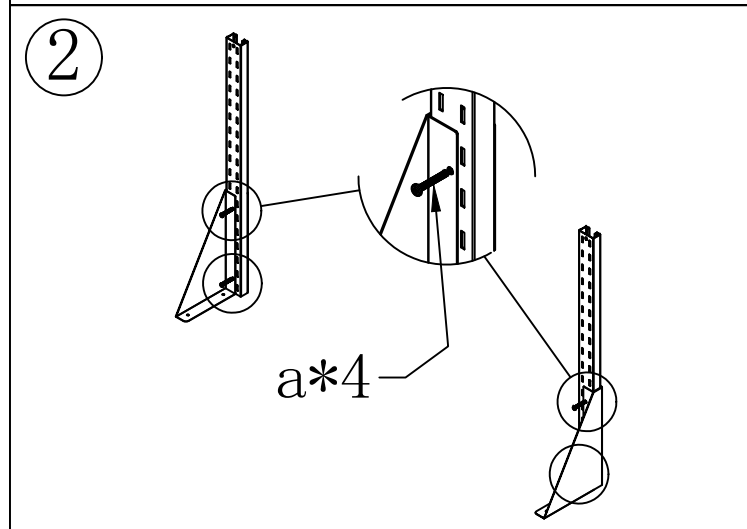
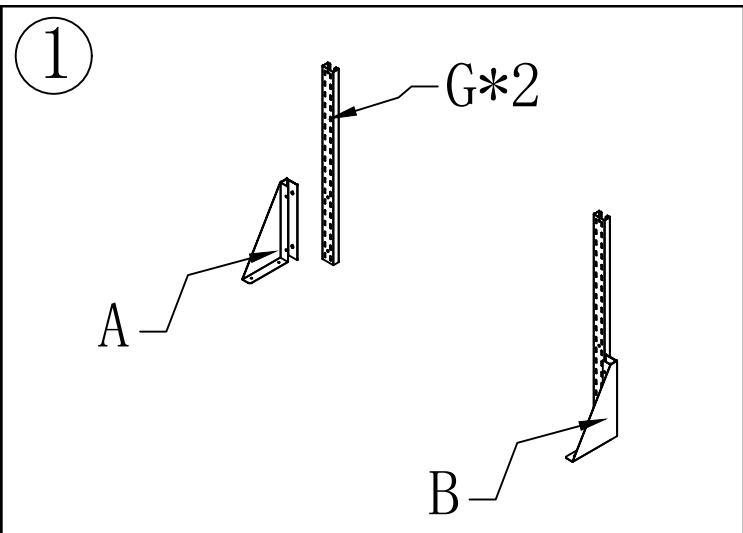
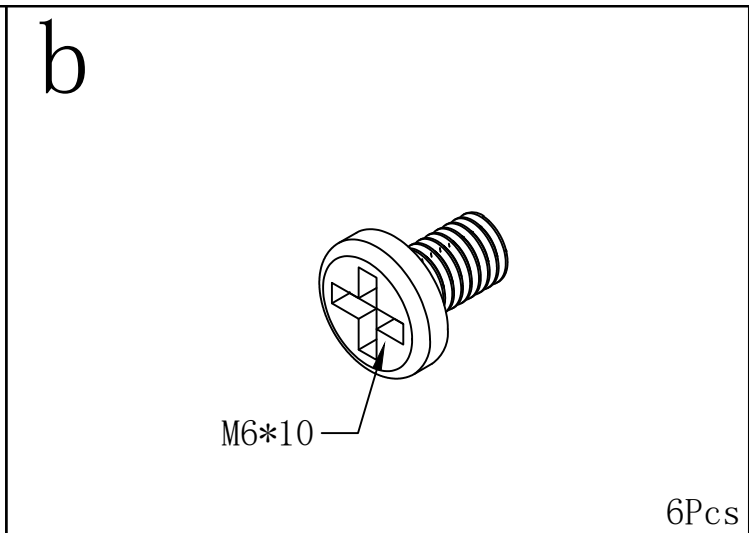
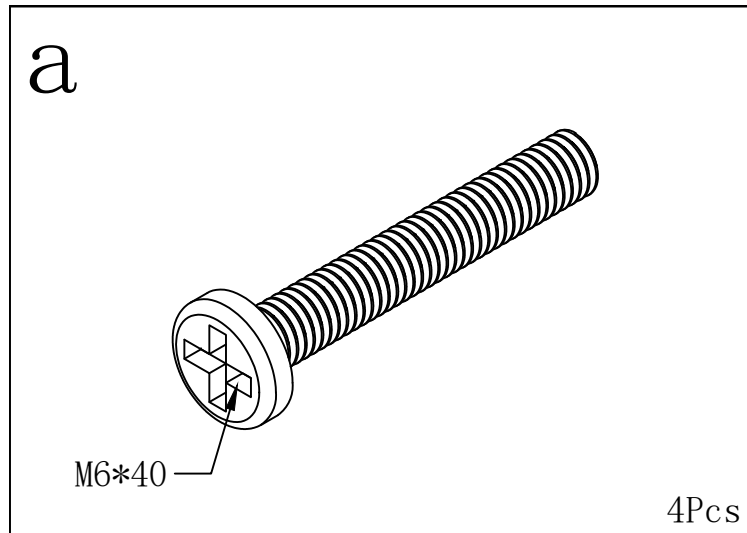

Z

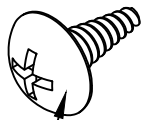

M5*15

9Pcs

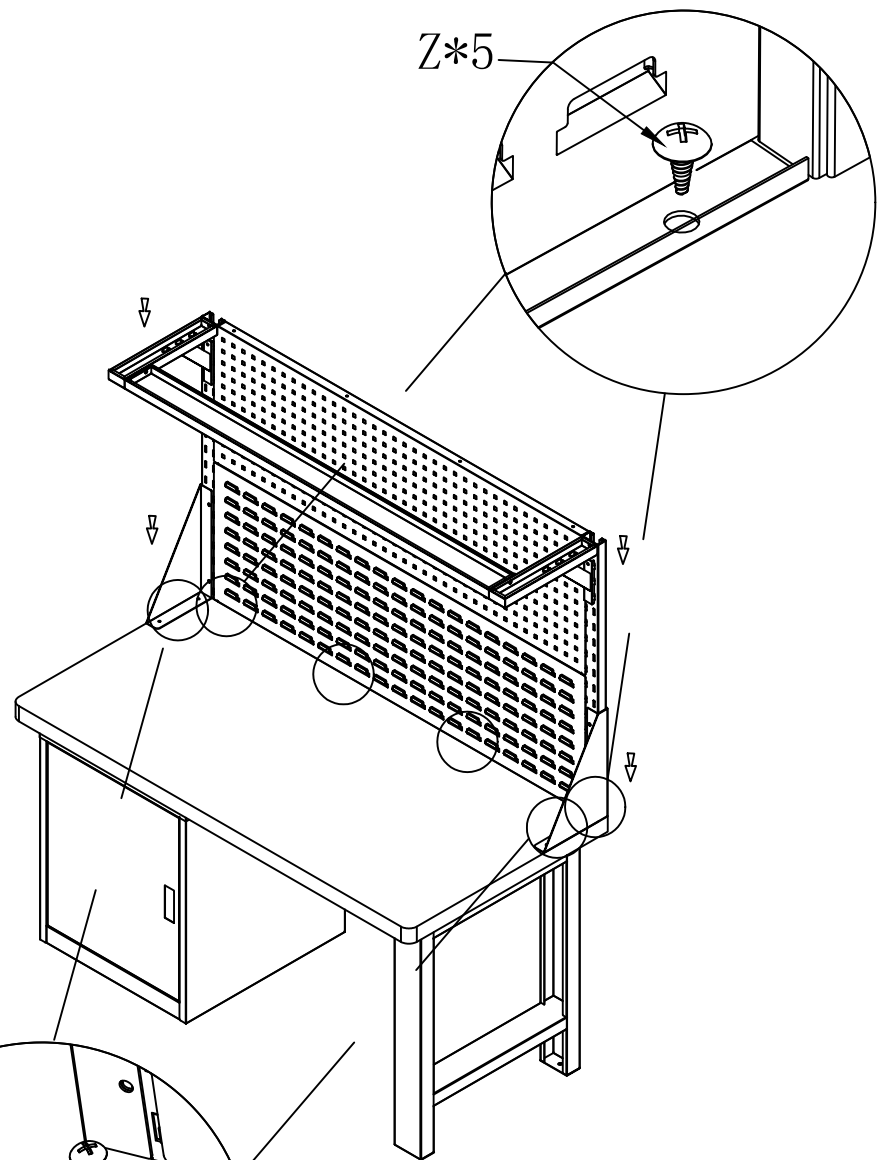
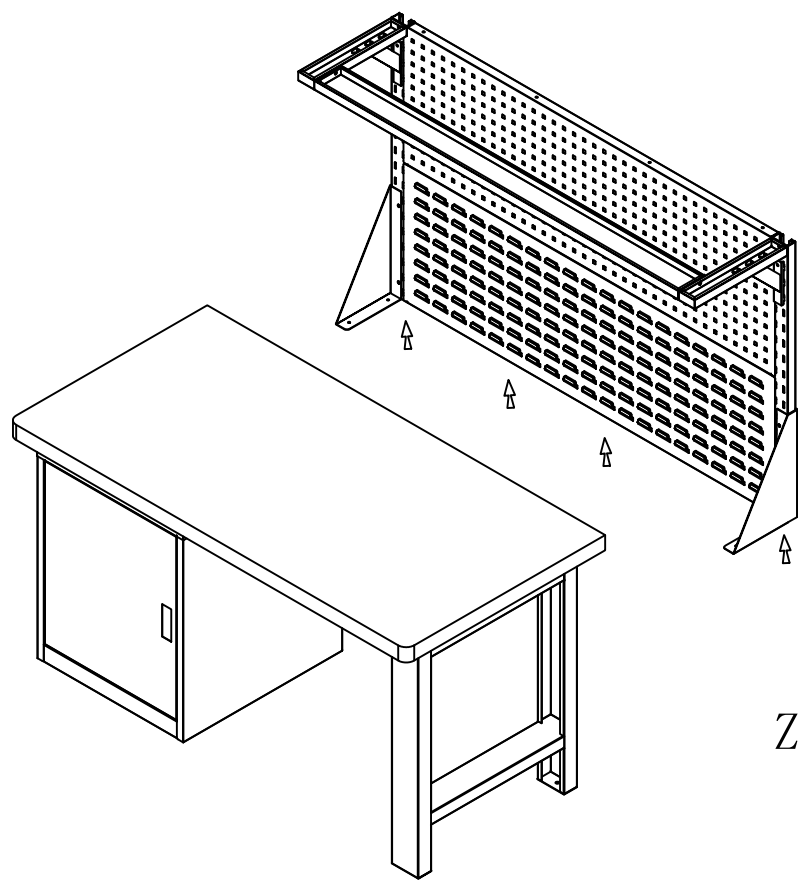

Z*5

Z*4