

1x

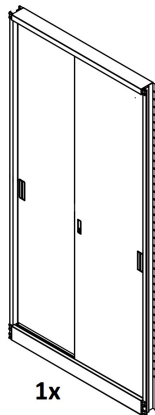

1x



1x

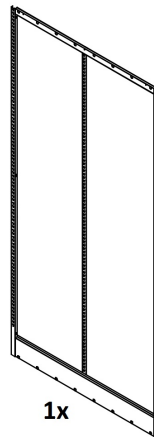

1x

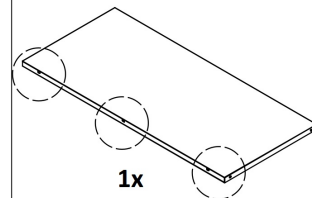

1x

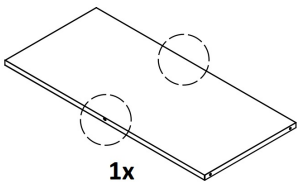
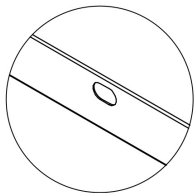

1x

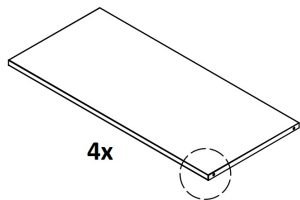
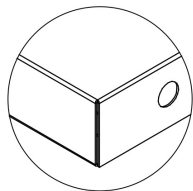

4x



16x

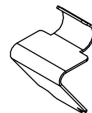

16x

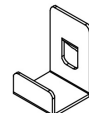

4x



18x



1x

1

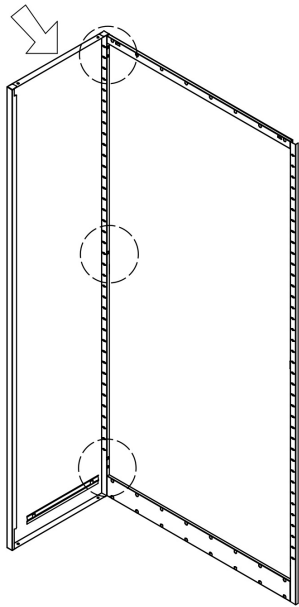

2

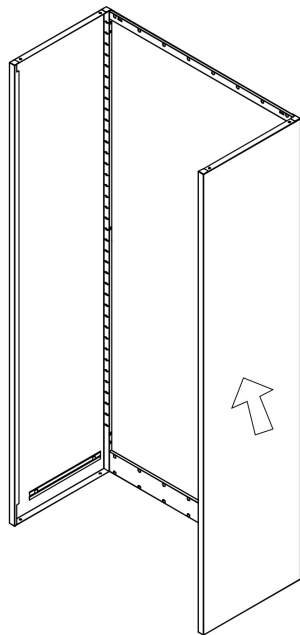

3

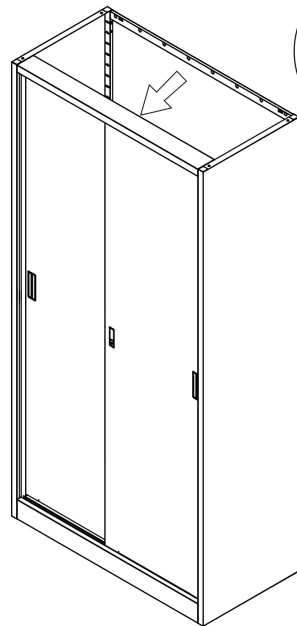

4

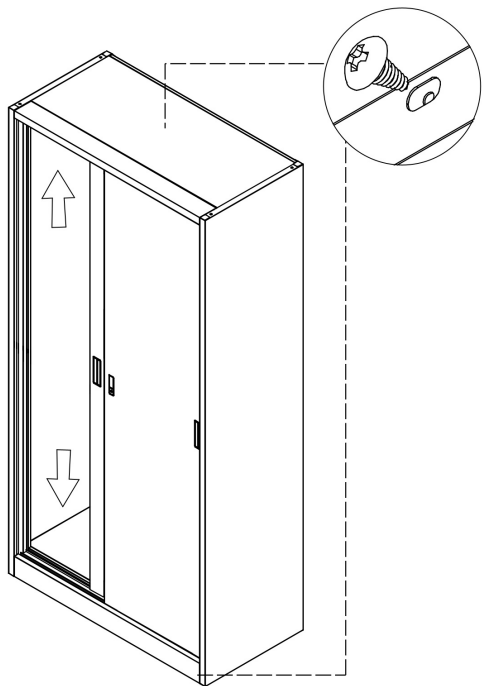

5

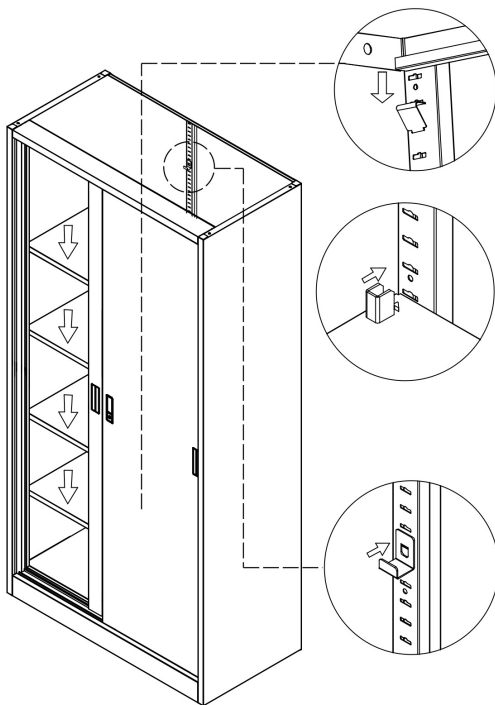

6

