













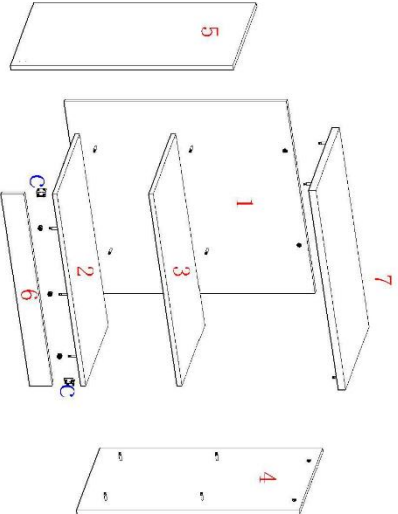
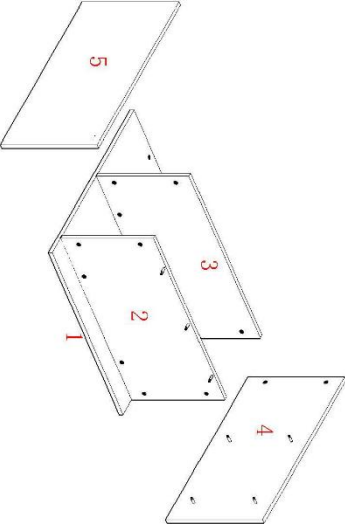

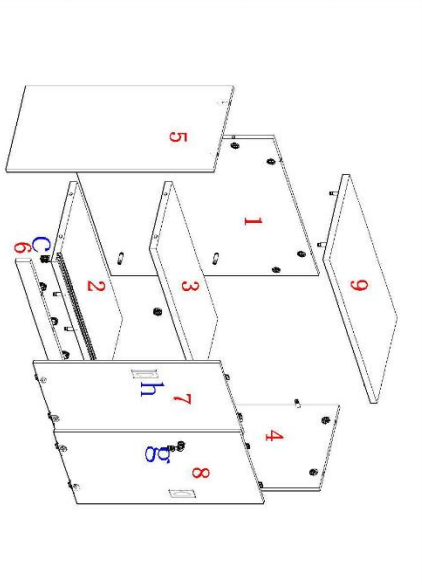



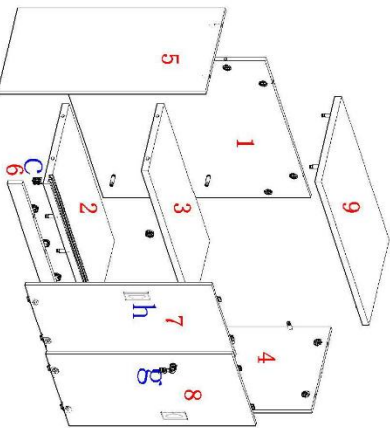



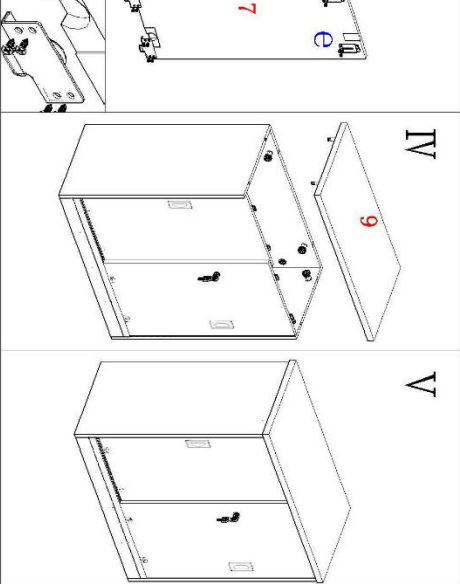





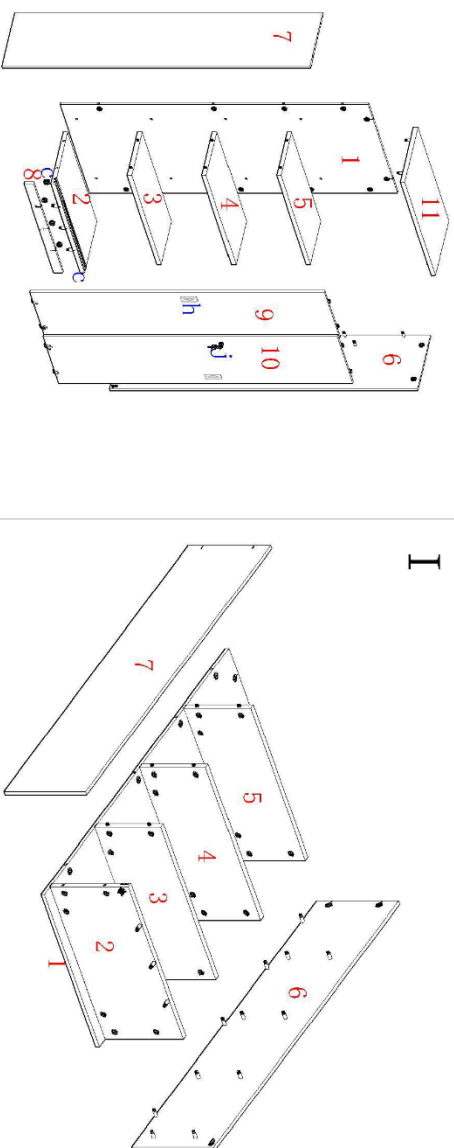





<p>25ks</p>  <p>a</p>	<p>25ks</p>  <p>b</p>	<p>2ks</p>  <p>c</p>	<p>8ks</p>  <p>d</p>	<p>II</p> 	<p>I</p> 

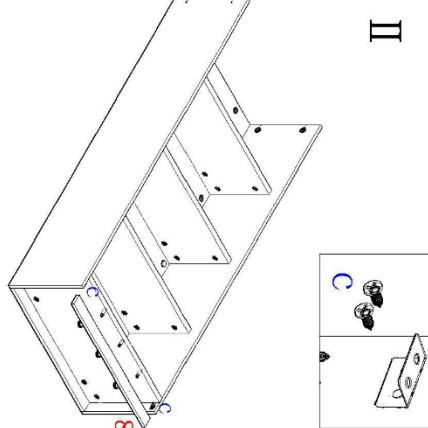
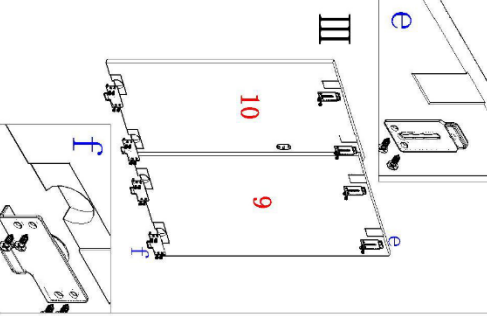
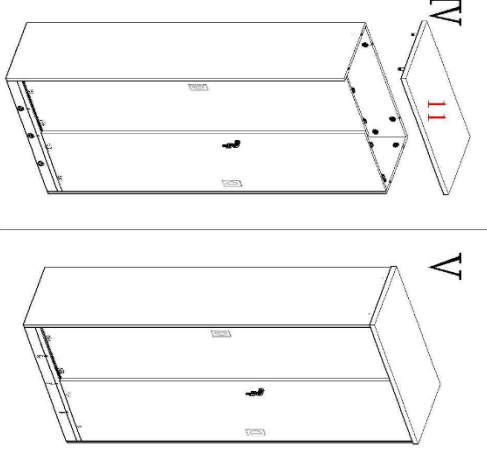

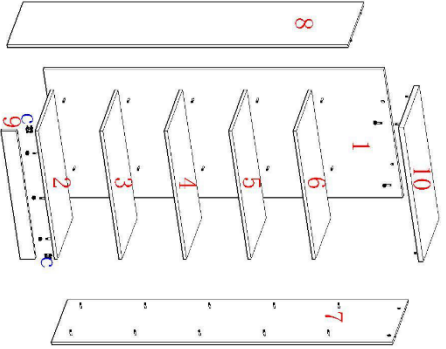
25ks	 a	 <p>I</p>	 <p>II</p>
25ks	 b		
2ks	 c		
30ks	 d		
4ks	 e		
4ks	 f	 <p>III</p>	 <p>IV</p>
1ks	 g		
2ks	 h		
		 <p>V</p>	 <p>VI</p>



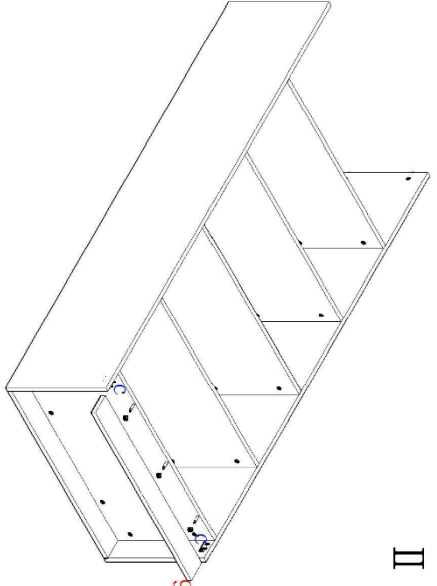
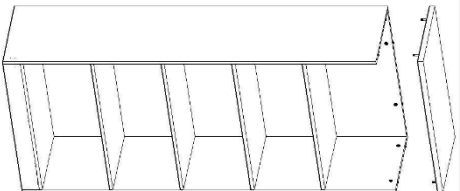
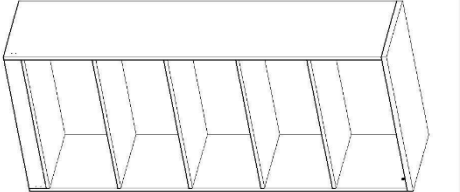

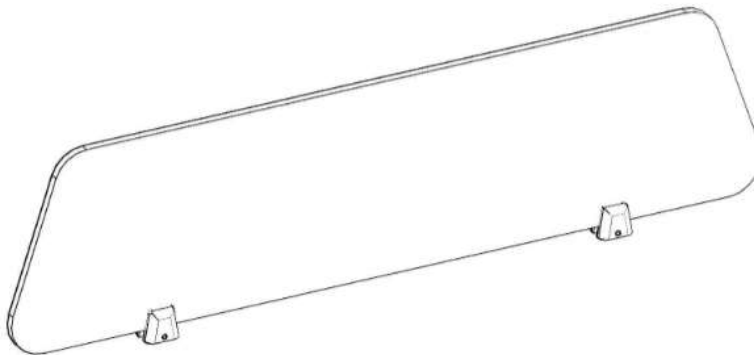
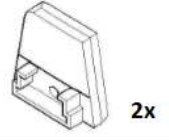
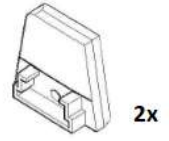
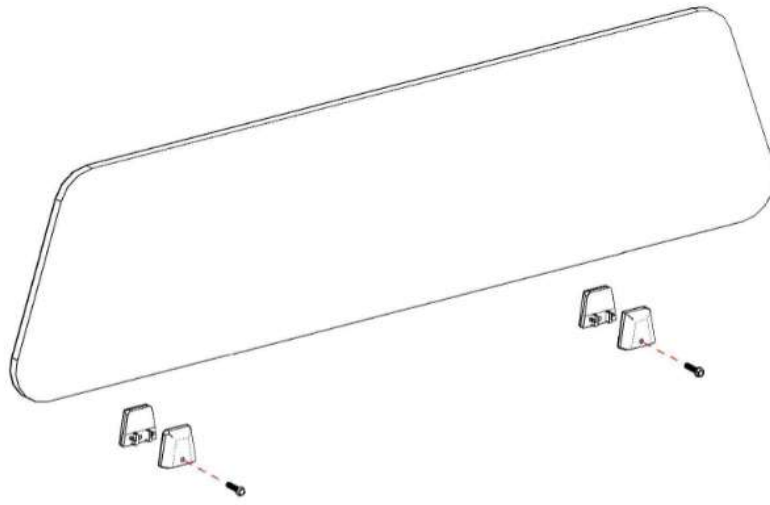
41ks			
41ks			
2ks			
30ks			
4ks			
4ks			
1ks			
2ks			
			
			
			



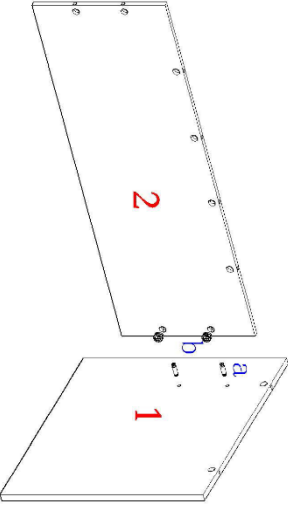
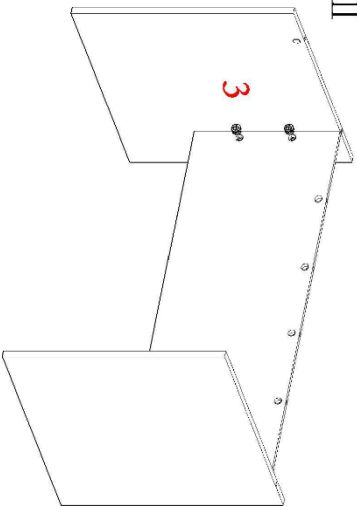
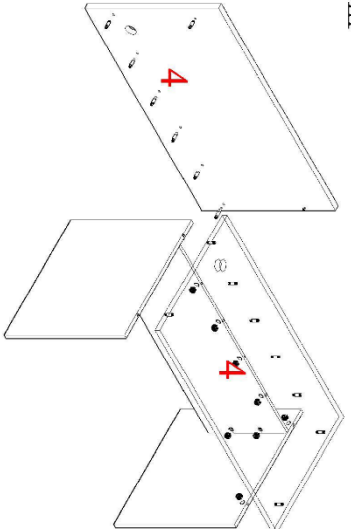
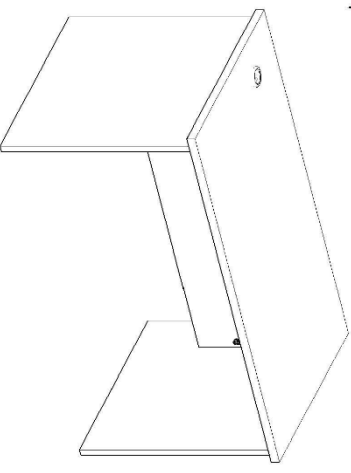

47ks	 <p>a</p>	 <p>I</p>
47ks	 <p>b</p>	
2ks	 <p>c</p>	
8ks	 <p>d</p>	
		 <p>II</p>
		 <p>III</p>
		 <p>IV</p>

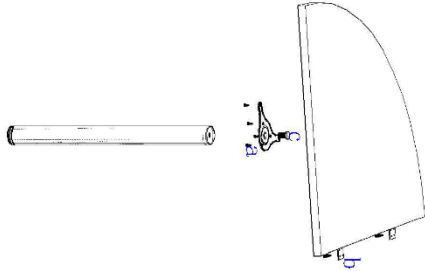
437277 - 437291

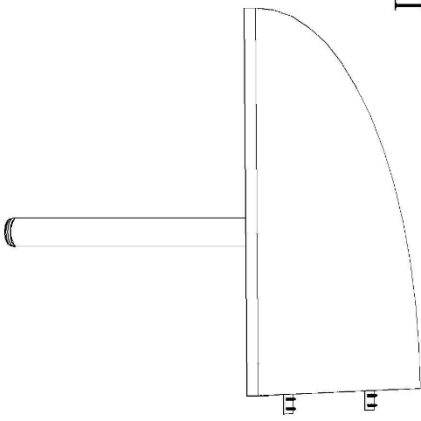

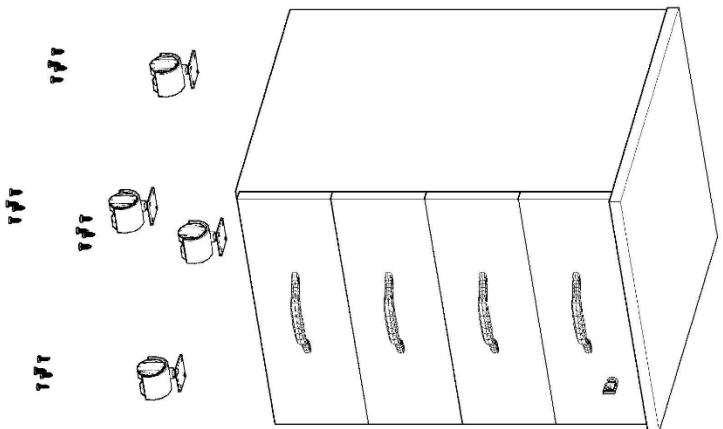
10ks					
10ks					
	a	I			
	b	II			
		III			
		IV			

<p>21ks</p> 	<p>I</p> 
<p>2ks</p> 	<p>II</p> 
<p>1ks</p> 	<p>III</p> 

8ks		a	I 		
4ks		b			
1ks		c			
16ks		d			
			II 